

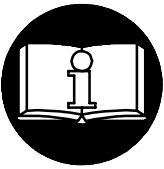

INSTRUCTIONS FOR MODEL LA419-EU 1/4" COLLET HEAVY DUTY DIE GRINDER

NOTICE

The Model LA419-EU Grinder is a compact, general purpose Grinder for tire buffing, metal finishing and weld dressing in confined areas. Ingersoll-Rand is not responsible for customer modification of tools for applications on which Ingersoll-Rand was not consulted.



! WARNING

**IMPORTANT SAFETY INFORMATION ENCLOSED.
READ THIS MANUAL BEFORE OPERATING TOOL.**

**IT IS THE RESPONSIBILITY OF THE EMPLOYER TO PLACE THE INFORMATION
IN THIS MANUAL INTO THE HANDS OF THE OPERATOR.**

FAILURE TO OBSERVE THE FOLLOWING WARNINGS COULD RESULT IN INJURY.

PLACING TOOL IN SERVICE

- Always operate, inspect and maintain this tool in accordance with all regulations (local, state, federal and country), that may apply to hand held/hand operated pneumatic tools.
- For safety, top performance, and maximum durability of parts, operate this tool at 90 psig (6.2 bar/620 kPa) maximum air pressure at the inlet with 3/8" (10 mm) inside diameter air supply hose.
- Always turn off the air supply and disconnect the air supply hose before installing, removing or adjusting any accessory on this tool, or before performing any maintenance on this tool.
- Do not use damaged, frayed or deteriorated air hoses and fittings.
- Be sure all hoses and fittings are the correct size and are tightly secured. See Dwg. TPD905-1 for a typical piping arrangement.
- Always use clean, dry air at 90 psig maximum air pressure. Dust, corrosive fumes and/or excessive moisture can ruin the motor of an air tool.
- Do not lubricate tools with flammable or volatile liquids such as kerosene, diesel or jet fuel.
- Do not remove any labels. Replace any damaged label.

USING THE TOOL

- Always wear eye protection when operating or performing maintenance on this tool.
- Always wear hearing protection when operating this tool.
- Keep hands, loose clothing and long hair away from rotating end of tool.
- Anticipate and be alert for sudden changes in motion during start up and operation of any power tool.
- Keep body stance balanced and firm. Do not overreach when operating this tool. High reaction torques can occur at or below the recommended air pressure.
- Tool shaft may continue to rotate briefly after throttle is released.
- Air powered tools can vibrate in use. Vibration, repetitive motions or uncomfortable positions may be harmful to your hands and arms. Stop using any tool if discomfort, tingling feeling or pain occurs. Seek medical advice before resuming use.
- Use accessories recommended by Ingersoll-Rand.
- This tool is not designed for working in explosive atmospheres.
- This tool is not insulated against electric shock.

NOTICE

The use of other than genuine Ingersoll-Rand replacement parts may result in safety hazards, decreased tool performance, and increased maintenance, and may invalidate all warranties.

Repairs should be made only by authorized trained personnel. Consult your nearest Ingersoll-Rand Authorized Servicer.

WARNING LABEL IDENTIFICATION

⚠ WARNING

FAILURE TO OBSERVE THE FOLLOWING WARNINGS COULD RESULT IN INJURY.

| | |
|---|---|
|  | ⚠ WARNING Always wear eye protection when operating or performing maintenance on this tool. |
|---|---|

| | |
|---|--|
|  | ⚠ WARNING Always wear hearing protection when operating this tool. |
|---|--|

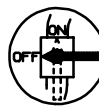
| | |
|---|---|
|  | ⚠ WARNING Always turn off the air supply and disconnect the air supply hose before installing, removing or adjusting any accessory on this tool, or before performing any maintenance on this tool. |
|---|---|



| | |
|---|--|
|  | ⚠ WARNING Air powered tools can vibrate in use. Vibration, repetitive motions or uncomfortable positions may be harmful to your hands and arms. Stop using any tool if discomfort, tingling feeling or pain occurs. Seek medical advice before resuming use. |
|---|--|

| | |
|---|--|
|  | ⚠ WARNING Do not carry the tool by the hose. |
|---|--|

| | |
|---|--|
|  | ⚠ WARNING Do not use damaged, frayed or deteriorated air hoses and fittings. |
|---|--|

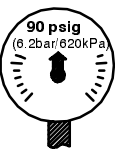
| | |
|---|--|
|  | ⚠ WARNING Keep body stance balanced and firm. Do not overreach when operating this tool. |
|---|--|

| | |
|---|--|
|  | ⚠ WARNING Operate at 90 psig (6.2 bar/620 kPa) Maximum air pressure. |
|---|--|

| | |
|---|---|
| International Warning Label: Order Part No. _____ | |
|  |  |

PLACING TOOL IN SERVICE

LUBRICATION



Ingersoll-Rand No. 50

Always use an air line lubricator with this tool. We recommend the following Filter-Lubricator-Regulator Unit:

C26-C4-A29

After each eight hours of operation, unless an air-line lubricator is used, inject 1/2 cc of Ingersoll-Rand No. 50 Oil into the air inlet before attaching the hose.

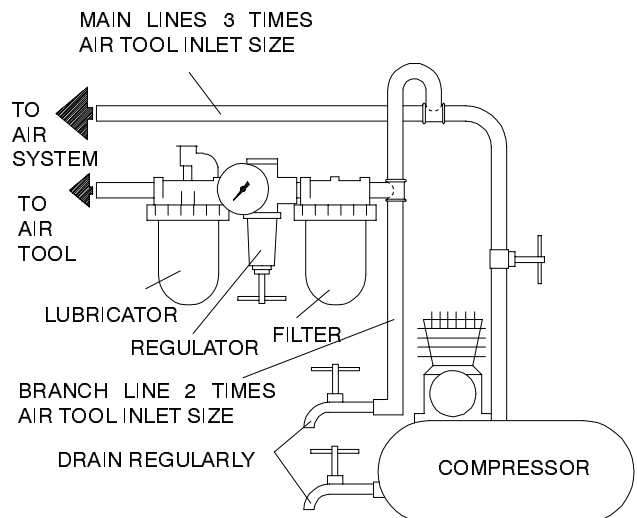

(Dwg. TPD905-1)

SPECIFICATIONS

| Model | Type of Handle | Collet Size | | Free Speed | ■ Sound Level dB (A) | | ◆ Vibrations Level m/s ² |
|----------|----------------|-------------|----|------------|----------------------|--------|--|
| | | in | mm | | Pressure | •Power | |
| LA419-EU | Lever | 1/4" | 6 | 25 000 | 89.8 | 102.8 | 4,4 |

- Tested in accordance with ANSI S5.1-1971 at free speed
- ◆ Tested in accordance with ISO8662-1 with artificial unbalanced load at 50% of rated speed for uncontrolled tools and at 80% rated free speed for controlled tools.
- ISO3744

DECLARATION OF CONFORMITY

We Ingersoll-Rand, Co.
(supplier's name)

Swan Lane, Hindley Green, Wigan WN2 4EZ
(address)

declare under our sole responsibility that the product,

Model LA419-EU 1/4" Collet Heavy Duty Die Grinder

to which this declaration relates, is in compliance with the provisions of
89/392/EEC, 91/368/EEC, 93/44/EEC AND 93/68/EEC Directives.

By using the following Principle Standards: ISO8662

Serial No. Range (1994 →) XUA XXXXX →

J. Cartwright
Name and signature of authorised persons

Chuck S. Zegrati
Name and signature of authorised persons

February, 1995
Date

February, 1995
Date

NOTICE

SAVE THESE INSTRUCTIONS. DO NOT DESTROY.

When the life of the tool has expired, it is recommended that the tool be disassembled, degreased and parts be separated by material so that they can be recycled.

MODE D'EMPLOI DE LA MINI MEULEUSE SÉRIE FORTE MODÈLE LA419-EU

NOTE

La meuleuse Modèle LA419-EU est une meuleuse compacte à usage général pour le polissage des pneus, la finition des métaux et le dressage des soudures dans des espaces restreints. Ingersoll-Rand ne peut être tenu responsable de la modification des outils par le client pour les adapter à des applications qui n'ont pas été approuvées par Ingersoll-Rand.

⚠ ATTENTION

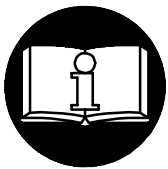

**D'IMPORTANTES INFORMATIONS DE SÉCURITÉ SONT JOINTES.
LIRE CE MANUEL AVANT D'UTILISER L'OUTIL.**

**L'EMPLOYEUR EST TENU DE COMMUNIQUER LES INFORMATIONS
DE CE MANUEL AUX EMPLOYÉS UTILISANT CET OUTIL.**

LE NON RESPECT DES AVERTISSEMENTS SUIVANTS PEUT CAUSER DES BLESSURES.

MISE EN SERVICE DE L'OUTIL

- Cet outil doit toujours être exploité, inspecté et entretenu conformément à toutes les réglementations (locales, départementales, fédérales et nationales), applicables aux outils pneumatiques tenus/commandés à la main.
- Pour la sécurité, les performances optimales et la durabilité maximale des pièces, cet outil doit être connecté à une alimentation d'air comprimé de 6,2 bar (620 kPa) maximum à l'entrée, avec un flexible de 10 mm de diamètre intérieur.
- Couper toujours l'alimentation d'air comprimé et débrancher le flexible d'alimentation avant d'installer, déposer ou ajuster tout accessoire sur cet outil, ou d'entreprendre une opération d'entretien quelconque sur l'outil.
- Ne pas utiliser des flexibles ou des raccords endommagés, effilochés ou détériorés.
- S'assurer que tous les flexibles et les raccords sont correctement dimensionnés et bien serrés. Voir Plan TPD905-1 pour un exemple type d'agencement des tuyauteries.
- Utiliser toujours de l'air sec et propre à une pression maximum de 6,2 bar. La poussière, les fumées corrosives et/ou une humidité excessive peuvent endommager le moteur d'un outil pneumatique.
- Ne jamais lubrifier les outils avec des liquides inflammables ou volatils tels que le kérosène, le gasol ou le carburant d'aviation.
- Ne retirer aucune étiquette. Remplacer toute étiquette endommagée.

UTILISATION DE L'OUTIL

- Porter toujours des lunettes de protection pendant l'utilisation et l'entretien de cet outil.
- Porter toujours une protection acoustique pendant l'utilisation de cet outil.
- Tenir les mains, les vêtements flous et les cheveux longs, éloignés de l'extrémité rotative de l'outil.
- Prévoir, et ne pas oublier, que tout outil motorisé est susceptible d'à-coups brusques lors de sa mise en marche et pendant son utilisation.
- Garder une position équilibrée et ferme. Ne pas se pencher trop en avant pendant l'utilisation de cet outil. Des couples de réaction élevés peuvent se produire à, ou en dessous, de la pression d'air recommandée.
- La rotation des accessoires de l'outil peut continuer pendant un certain temps après le relâchement de la gâchette.
- Les outils pneumatiques peuvent vibrer pendant l'exploitation. Les vibrations, les mouvements répétitifs et les positions inconfortables peuvent causer des douleurs dans les mains et les bras. N'utiliser plus d'outils en cas d'inconfort, de picotements ou de douleurs. Consulter un médecin avant de recommencer à utiliser l'outil.
- Utiliser les accessoires recommandés par Ingersoll-Rand.
- Cet outil n'est pas conçu pour fonctionner dans des atmosphères explosives.
- Cet outil n'est pas isolé contre les chocs électriques.

NOTE

L'utilisation de rechanges autres que les pièces d'origine Ingersoll-Rand peut causer des risques d'insécurité, réduire les performances de l'outil et augmenter l'entretien, et peut annuler toutes les garanties.

Les réparations ne doivent être effectuées que par des réparateurs qualifiés autorisés. Consultez votre Centre de Service Ingersoll-Rand le plus proche.

Adressez toutes vos communications au Bureau Ingersoll-Rand ou distributeur le plus proche.

© Ingersoll-Rand Company 1996

Imprimé aux É.U.

INGERSOLL-RAND®
PROFESSIONAL TOOLS

SIGNIFICATION DES ÉTIQUETTES D'AVERTISSEMENT

ATTENTION

LE NON RESPECT DES AVERTISSEMENTS SUIVANTS PEUT CAUSER DES BLESSURES.



ATTENTION
Porter toujours des lunettes de protection pendant l'utilisation et l'entretien de cet outil.



ATTENTION
Porter toujours une protection acoustique pendant l'utilisation de cet outil.

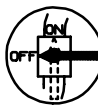

ATTENTION
Couper toujours l'alimentation d'air comprimé et débrancher le flexible d'alimentation avant d'installer, déposer ou ajuster tout accessoire sur cet outil, ou d'entreprendre une opération d'entretien quelconque sur l'outil.



ATTENTION
Les outils pneumatiques peuvent vibrer pendant l'exploitation. Les vibrations, les mouvements répétitifs et les positions inconfortables peuvent causer des douleurs dans les mains et les bras. N'utiliser plus d'outils en cas d'inconfort, de picotements ou de douleurs. Consulter un médecin avant de recommencer à utiliser l'outil.



ATTENTION
Ne pas transporter l'outil par son flexible.



ATTENTION
Ne pas utiliser des flexibles ou des raccords endommagés, effilochés ou détériorés.



ATTENTION
Garder une position équilibrée et ferme. Ne pas se pencher trop en avant pendant l'utilisation de cet outil.



ATTENTION
Utiliser de l'air comprimé à une pression maximum de 6,2 bar (620 kPa).

Etiquette d'avertissement internationale:
Commander Pièce No. _____



MISE EN SERVICE DE L'OUTIL

LUBRIFICATION



Ingersoll-Rand No. 50

Utiliser toujours un lubrificateur avec cet outil. Nous recommandons l'emploi du filtre-régulateur-lubrificateur suivant :

C26-C4-A29

Toutes les huit heures de fonctionnement, sauf si un lubrificateur d'air comprimé est utilisé, injecter 1/2 cm³ d'huile Ingersoll-Rand No. 50 dans le raccord d'admission avant de connecter le flexible.

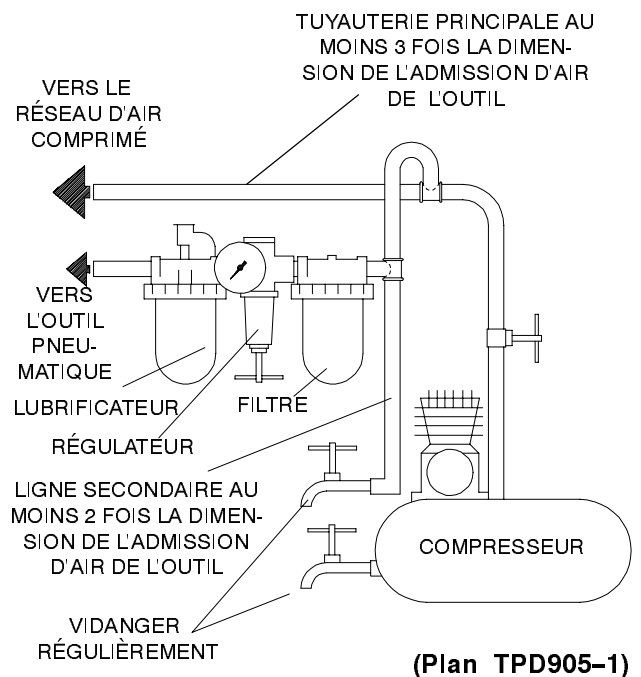

SPÉCIFICATIONS

| Modèle | Type de Poignée | Diamètre de la pince | | Vitesse à vide | ■ Niveau de son dB (A) | | ◆ Niveau de vibration m/s ² |
|----------|-----------------|----------------------|----|----------------|------------------------|-------------|--|
| | | pouces | mm | | Pression | • Puissance | |
| LA419-EU | Lever | 1/4" | 6 | 25 000 | 89.8 | 102.8 | 4,4 |

- Testé conformément à ANSI S5.1-1971 en vitesse libre
- ◆ Testé conformément à ISO8662-1 avec charge artificielle déséquilibrée à 50% de la vitesse nominale pour outils non-contrôlés et à 80% de la vitesse libre nominale pour outils contrôlés.
- ISO3744

BEDIENUNGSANLEITUNG FÜR HOCHLEISTUNGS – KLEINSTSCHLEIFMASCHINE DER BAUREIHE LA419-EU (SPANNFUTTER 1/4 ZOLL)

HINWEIS

Die Schleifmaschine der Baureihe LA419-EU ist ein kompaktes universalgerät zum schleifen von reifen metallendbearbeitung und putzen von schweissanähten auf engem raum. Ingersoll-Rand lehnt jede Haftung für Veränderungen an Werkzeugen ab, die ohne vorherige Rücksprache mit Ingersoll-Rand vorgenommen werden.

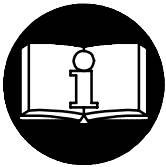

⚠ ACHTUNG

NACHFOLGEND WICHTIGE SICHERHEITSHINWEISE.
DIESE BETRIEBSANWEISUNG VOR INBETRIEBNAHME DES WERKZEUGES
UNBEDINGT LESEN.

DER ARBEITGEBER IST VERPFLICHTET, DIE IN DIESEM HANDBUCH GEGEBENEN
INFORMATIONEN DEM BEDIENER ZUGÄNGLICH ZU MACHEN.

DIE NICHTEINHALTUNG DIESER WARNHINWEISE KANN ZU VERLETZUNGEN FÜHREN.

INBETRIEBNAHME DES WERKZEUGES

- Das Werkzeug stets nach den örtlich und landesweit geltenden Vorschriften für handgehaltene/handbetriebene Druckluftwerkzeuge betreiben.
- Zur Erzielung höchster Sicherheit, Leistung und Haltbarkeit der Teile sollte dieses Werkzeug mit einem maximalen Luftdruck von 6,2 bar/620 kPa am Lufteinlaß und einem Luftzufuhrschlauch 10 mm Innendurchmesser betrieben werden.
- Vor Montage, Demontage oder Verstellung von Aufsatzteilen bzw. Wartung dieses Werkzeuges die Druckluftversorgung allseitig abschalten und Druckluftschlauch abschließen.
- Keine beschädigten, durchgescheuerten oder abgenutzten Luftschläuche und Anschlüsse verwenden.
- Darauf achten, daß alle Schläuche und Anschlüsse die passende Größe haben und korrekt befestigt sind. In Zeichnung TPD905-1 ist eine typische Rohrleitungsanordnung abgebildet.
- Stets saubere, trockene Luft verwenden und einen Luftdruck von 6,2 bar verwenden. Staub, ätzende Dämpfe und/oder Feuchtigkeit können den Motor eines Druckluftwerkzeuges beschädigen.
- Die Werkzeuge nicht mit brennbaren oder flüchtigen Flüssigkeiten wie Kerosin und Diesel schmieren.
- Keine Schilder entfernen. Beschädigte Schilder austauschen.

WERKZEUGEINSATZ

- Beim Betreiben oder Warten dieses Werkzeuges stets Augenschutz tragen.
- Beim Betreiben dieses Werkzeuges stets Gehörschutz tragen.
- Hände, lose Bekleidungsstücke und lange Haare vom rotierenden Ende des Werkzeuges fernhalten.
- Bei Start und Betrieb eines Werkzeuges auf Rückschlag achten und darauf vorbereitet sein.
- Während des Betriebes für festen Halt sorgen und den Körper nicht zu weit vorlehnen. Bei Betrieb mit empfohlenem oder niedrigerem Luftdruck können hohe Reaktionsdrehmomente auftreten.
- Nach dem Loslassen des Drückers kann die Welle des Werkzeuges noch kurz weiterdrehen.
- Druckluftbetriebene Werkzeuge können während des Betriebs vibrieren. Vibrationen, häufige gleichförmige Bewegungen oder unbequeme Positionen können schädlich für Hände und Arme sein. Bei Unbehagen, Kribbeln oder Schmerzen das Werkzeug nicht mehr benutzen. Vor dem erneuten Arbeiten mit dem Werkzeug ärztliche Hilfe aufsuchen.
- Stets von Ingersoll-Rand empfohlenes Zubehör verwenden.
- Das Werkzeug ist nicht für die Arbeit in explosiven Atmosphären geeignet.
- Dieses Werkzeug ist nicht gegen elektrischen Schlag isoliert.

HINWEIS

Die Verwendung von nicht Original-Ingersoll-Rand-Ersatzteilen kann Sicherheitsrisiken, verringerte Standzeit und erhöhten Wartungsbedarf nach sich ziehen und alle Garantieleistungen ungültig machen.

Reparaturen sollen nur von geschultem Personal durchgeführt werden. Wenden Sie sich an Ihre nächste Ingersoll-Rand-Niederlassung oder den autorisierten Fachhandel.

Wenden Sie sich bei Rückfragen an Ihre nächste Ingersoll-Rand-Niederlassung oder den autorisierten Fachhandel

© Ingersoll-Rand Company 1996

Druck: U.S.A.

INGERSOLL-RAND®
PROFESSIONAL TOOLS

ANWEISUNGEN AUF WARNSCHILDERN

⚠ ACHTUNG

DIE NICHT-EINHALTUNG DIESER WARNSCHILDER KANN ZU VERLETZUNGEN FÜHREN.



⚠ ACHTUNG
Beim Betreiben oder Warten dieses Werkzeuges stets Augenschutz tragen.



⚠ ACHTUNG
Beim Betreiben dieses Werkzeuges stets Gehörschutz tragen.



⚠ ACHTUNG
Vor Wartungsarbeiten oder dem Austausch von Zubehör ist das Werkzeug von der Druckluftversorgung abzuschalten.



⚠ ACHTUNG
Druckluftbetriebene Werkzeuge können während des Betriebs vibrieren. Vibrationen, häufige gleichförmige Bewegungen oder unbequeme Positionen können schädlich für Hände und Arme sein. Bei Unbehagen, Kribbeln oder Schmerzen das Werkzeug nicht mehr benutzen. Vor dem erneuten Arbeiten mit dem Werkzeug ärztliche Hilfe suchen.



⚠ ACHTUNG
Das Werkzeug nicht am Schlauch tragen.



⚠ ACHTUNG
Keine beschädigten, durchgescheuerten oder abgenutzten Luftschläuche und Anschlüsse verwenden.



⚠ ACHTUNG
Während des Betriebs für festen Halt sorgen und den Körper nicht zu weit nach vorne beugen.

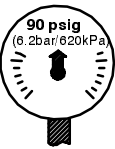

⚠ ACHTUNG
Mit einem maximalen Luftdruck von 6,2 bar/620 kPa (90 psig) betreiben.

Internationales Warnschild:
Teile Nr. _____

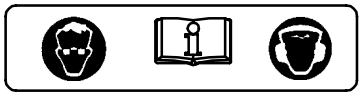

INBETRIEBNAHME DES WERKZEUGES

SCHMIERUNG



Ingersoll-Rand Nr. 50

Das Werkzeug stets mit einem Leitungslöler verwenden. Es wird folgende Filter-Regler-Öler-Kombination empfohlen:

C26-C4-A29

Wird kein Leitungslöler verwendet, **nach jeweils acht Betriebsstunden** 0,5 cm Ingersoll-Rand-Öl Nr. 50 vor dem Anschließen des Luftschlauches in den Lufteinlaß geben.

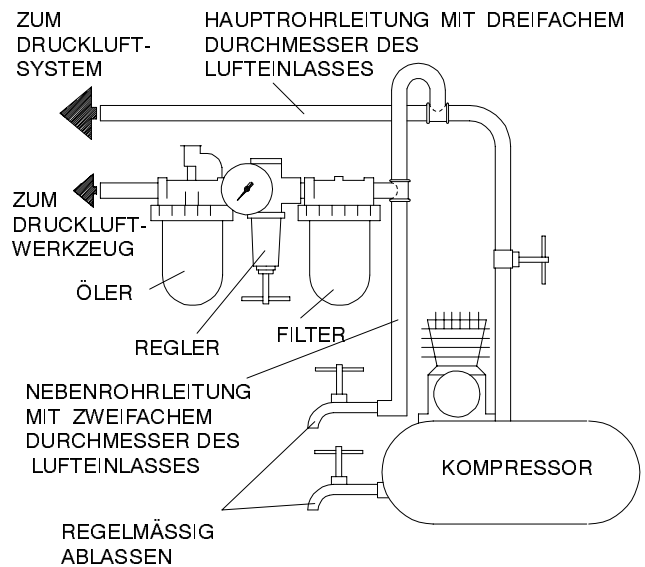

(Zeichn. TPD905-1)

TECHNISCHE DATEN

| Modell | Griffart | Spannfuttergröße | | Freie Drehzahl | ■ Schallpegel dB (A) | | ◆ Schwingungsintensität m/s ² |
|----------|----------|------------------|----|----------------|----------------------|------------|--|
| | | Zoll | mm | | Druck | • Leistung | |
| LA419-EU | Hebel | 1/4" | 6 | 25 000 | 89.8 | 102.8 | 4,4 |

- Gemäß ANSI S5.1-1971 bei freier Drehzahl getestet
- ◆ Gemäß ISO8662-1 mit einer künstlichen, unsymmetrischen Belastung bei 50% der Nenndrehzahl für unregelte Werkzeuge und 80% der freien Nenndrehzahl für geregelte Werkzeuge getestet.
- ISO3744



ISTRUZIONI PER LA SMERIGLIATRICE HEAVY DUTY DI STAMPI CON PINZA DI 1/4" MODELLO LA419-EU

AVVISO

La smerigliatrice modello LA419-EU è un'attrezzo multiuso per la pulitura di pneumatici, la rifinitura del metallo e la pulitura di saldatura in spazi ristretti.

La Ingersoll-Rand non è responsabile delle modifiche apportate agli attrezzi dai clienti per adattarli ad applicazioni per le quali la Ingersoll-Rand non sia stata interpellata.

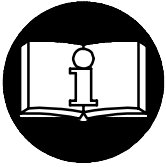

AVVERTENZA

**IMPORTANTE INFORMAZIONE DI SICUREZZA ACCLUSA.
LEGGERE IL PRESENTE MANUALE PRIMA DI USARE L'ATTREZZO.**

**È RESPONSABILITÀ DEL DATORE DI LAVORO DI METTERE QUEST'INFORMAZIONE
NELLE MANI DELL'OPERATORE.**

**LA MANCATA OSSERVANZA DELLE SEGUENTI AVVERTENZE PUÒ CAUSARE LESIONI
FISICHE**

MESSA IN SERVIZIO DELL'ATTREZZO

- Usare, ispezionare e mantenere sempre quest'attrezzo secondo tutti i regolamenti (locali, statali, federali e nazionale), che possano essere applicabili agli attrezzi a mani pneumatici.
- Per sicurezza, massime prestazioni e massima durabilità delle parti, usare quest'attrezzo ad una massima pressione d'aria di 90 psig (6,2 bar/620 kPa) all'ingresso con un flessibile di alimentazione dell'aria con diametro interno di 3/8" (10 mm).
- Disinserire sempre l'alimentazione aria e staccare il relativo tubo dall'attrezzo, prima di installare, togliere o regolare qualsiasi accessorio, oppure prima di eseguire qualsiasi operazione di manutenzione dell'attrezzo.
- Non adoperare tubi e raccordi danneggiati, consunti o deteriorati.
- Assicurarsi che tutti i tubi ed i raccordi siano delle corrette dimensioni e saldamente serrati. Consultare il disegno TPD905-1 per una tipica disposizione dei tubi.
- Usare sempre aria pulita ed asciutta alla pressione max di 90 psig. Polvere, fumi corrosivi e/o un eccesso di umidità possono rovinare il motore di un attrezzo pneumatico.
- Non lubrificare gli attrezzi con liquidi infiammabili o volatili come kerosene, gasolio o combustibile per aviogetti.
- Non togliere nessuna etichetta. Sostituire eventuali etichette danneggiate.

COME USARE L'ATTREZZO

- Indossare sempre delle cuffie protettive quando si adopera questo attrezzo.
- Tenere le mani, gli indumenti sciolti ed i capelli lunghi distanti dall'estremità battente dell'attrezzo.
- Fare attenzione e cercare di anticipare improvvise variazioni di movimento durante l'avviamento e l'uso di qualsiasi attrezzo pneumatico.
- Nell'usare l'attrezzo, mantenere con il corpo una posizione salda e ben bilanciata. Non sbilanciarsi durante l'uso di questo attrezzo. Delle elevate reazioni di coppia si possono verificare alla pressione d'aria raccomandata o inferiore.
- L'albero dell'attrezzo potrebbe continuare a funzionare brevemente dopo che è stata disinserta l'immissione.
- Gli attrezzi pneumatici possono vibrare durante l'uso. Le vibrazioni, i movimenti ripetitivi o le posizioni scomode possono risultare dannosi per le mani e le braccia. Interrompere l'uso dell'attrezzo se si avvertono sintomi di disagio fisico, formicolio o dolore. Interpellare un medico prima di riprendere il lavoro.
- Usare accessori raccomandati dalla Ingersoll-Rand.
- Questo utensile non è stato progettato per operare in atmosfere esplosive.
- Questo utensile non è isolato contro le scosse elettriche.

AVVISO

L'uso di ricambi non originali Ingersoll-Rand potrebbe causare condizioni di pericolosità, compromettere le prestazioni dell'attrezzo ed aumentare la necessità di manutenzione, inoltre potrebbe invalidare tutte le garanzie.

Le riparazioni devono essere effettuate soltanto da personale autorizzato e qualificato. Rivolgersi al più vicino centro di assistenza tecnica Ingersoll-Rand.

IDENTIFICAZIONE DELLE ETICHETTE DI AVVERTENZA

▲ AVVERTENZA

LA MANCATA OSSERVAZIONE DELLE SEGUENTI AVVERTENZE PUÒ CAUSARE LESIONI FISICHE



▲ AVVERTENZA
Indossare sempre degli occhiali protettivi quando si adopera questo attrezzo o se ne esegue la manutenzione.



▲ AVVERTENZA
Indossare sempre delle cuffie protettive quando si adopera questo attrezzo.



▲ AVVERTENZA
Disinserire sempre l'alimentazione aria e staccare il relativo tubo, prima di installare, togliere o regolare qualsiasi accessorio, oppure prima di eseguire qualsiasi operazione di manutenzione dell'attrezzo.



▲ AVVERTENZA
Gli attrezzi pneumatici possono vibrare durante l'uso. Le vibrazioni, i movimenti ripetitivi o le posizioni scomode possono risultare dannosi per le mani e le braccia. Interrompere l'uso dell'utensile se si avvertono sintomi di disagio fisico, formicolio o dolore. Interpellare un medico prima di riprendere il lavoro.



▲ AVVERTENZA
Non trasportare l'attrezzo tenendolo per il tubo.



▲ AVVERTENZA
Non adoperare tubi e raccordi danneggiati, consumati o deteriorati.



▲ AVVERTENZA
Nell'usare l'attrezzo, mantenere con il corpo una posizione salda e ben bilanciata. Non sbilanciarsi durante l'uso di questo attrezzo.



▲ AVVERTENZA
Lavorare con massima pressione aria di 90 psig (6,2 bar/620 kPa).

Etichette di avvertenza internazionali:
Ordine Parte Nr. _____



MESSA IN SERVIZIO DELL'ATTREZZO

LUBRIFICAZIONE



Ingersoll-Rand Nr. 50

Con questo attrezzo usare sempre un lubrificatore di linea. Si raccomanda l'uso del seguente gruppo filtro-regolatore-lubrificatore:

C26-C4-A29

Dopo ogni otto ore di funzionamento, a meno che viene usato un lubrificatore di linea, iniettare 1/2 cc di olio Ingersoll-Rand Nr. 50 nell'entrata aria prima di staccare il tubo.

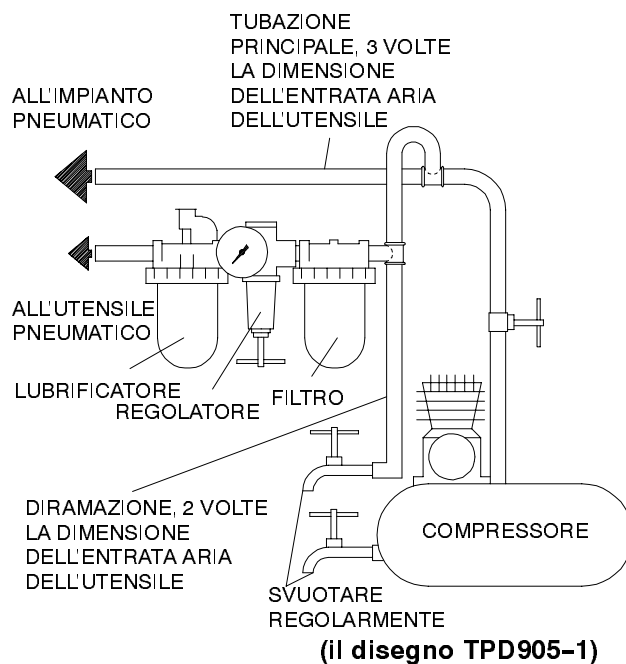

SPECIFICA

| Modello | Tipo d'impugnatura | Dimensione della pinza | | Velocità libera | ■ Livello suono dB (A) | | ◆ Livello di vibrazione m/s ² |
|----------|--------------------|------------------------|----|-----------------|------------------------|-----------|--|
| | | in | mm | | Pressione | • Potenza | |
| LA419-EU | Leva | 1/4" | 6 | 25 000 | 89.8 | 102.8 | 4,4 |

- Collaudato secondo i criteri ANSI S5.1-1971 a velocità libera
- ◆ Collaudato secondo i criteri ISO8662-1 con carico artificiale non bilanciato a 50% della velocità nominale per attrezzi non regolamentari e a velocità libera nominale dell'80% per attrezzi regolamentari.

• ISO3744

DICHIARAZIONE DI CONFORMITÀ

Noi Ingersoll-Rand, Co.
(nome del fornitore)

Swan Lane, Hindley Green, Wigan WN2 4EZ
(indirizzo)

dichiariamo sotto la nostra unica responsabilità che il prodotto:

Smerigliatrice Heavy Duty di stampi con pinza di 1/4" modello LA419-EU

a cui si riferisce la presente dichiarazione è conforme alle normative delle direttive:

89/392/EEC, 91/368/EEC, 93/44/EEC, 93/68/EEC

secondo i seguenti standard: ISO8662

Numeri di Serie: (1994 →) XUA XXXXX →

J. Cartwright
Nome e firma delle persone autorizzate

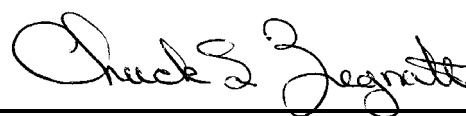
Chuck S. Zegrati
Name and signature of authorised persons

Bebbraio, 1995
Data

February, 1995
Date

AVVISO

CONSERVARE QUESTE ISTRUZIONI. NON DISTRUGGERLE.

Quando l'attrezzo è diventato inutilizzabile, si raccomanda di smontarlo, sgrassarlo e separare i componenti secondo i materiali in modo da poterli riciclare.

INSTRUCCIONES PARA AMOLADORA DE TROQUELES PARA SERVICIO PESADO DE PINZA DE 1/4 PULG. MODELO LA419-EU

NOTA

La amoladora modelo LA419-EU es una amoladora compacta de uso general para pulido de neumáticos, rectificación de metales y repaso de soldaduras en espacios reducidos. Ingersoll-Rand no aceptará responsabilidad alguna por la modificación de las herramientas efectuada por el cliente para las aplicaciones que no hayan sido consultadas con Ingersoll-Rand.

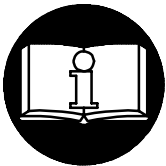

AVISO

SE ADJUNTA INFORMACIÓN IMPORTANTE DE SEGURIDAD.
LEA ESTE MANUAL ANTES DE UTILIZAR LA HERRAMIENTA.

ES RESPONSABILIDAD DE LA EMPRESA ASEGURARSE DE QUE EL OPERARIO ESTÉ
AL TANTO DE LA INFORMACIÓN QUE CONTIENE ESTE MANUAL.

EL HACER CASO OMISO DE LOS AVISOS SIGUIENTES PODRÍA OCASIONAR
LESIONES.

PARA PONER LA HERRAMIENTA EN SERVICIO

- Utilice, inspeccione y mantenga esta herramienta siempre de acuerdo con todas las normativas locales y nacionales que se apliquen a las herramientas neumáticas de utilización manual o que se sujeten con la mano.
- Para mayor seguridad, rendimiento óptimo y larga vida útil de las piezas, utilice esta herramienta a una presión de aire máxima de 90 psig (6,2 bar/620 kPa) con una manguera de suministro de aire con diámetro interno de 10 mm.
- Corte siempre el suministro de aire y desconecte la manguera de suministro de aire antes de instalar, desmontar o ajustar cualquier accesorio de esta herramienta, o antes de realizar cualquier operación de mantenimiento de la misma.
- No utilice mangueras de aire y racores dañados, desgastados o deteriorados.
- Asegúrese de que todos los racores y mangueras sean del tamaño correcto y estén bien apretados. El Esq. TPD905-1 muestra una disposición característica de las tuberías.
- Use siempre aire limpio y seco a una presión máxima de 90 psig (6,2 bar/620 kPa). El polvo, los gases corrosivos y el exceso de humedad pueden estropear el motor de una herramienta neumática.
- No lubrique las herramientas con líquidos inflamables o volátiles tales como queroseno, gasoil o combustible para motores a reacción.
- No saque ninguna etiqueta. Sustituya toda etiqueta dañada.

UTILIZACIÓN DE LA HERRAMIENTA

- Lleve siempre protección ocular cuando utilice esta herramienta o realice operaciones de mantenimiento en la misma.
- Lleve siempre protección para los oídos cuando utilice esta herramienta.
- Mantenga las manos, la ropa suelta y el cabello largo alejados del extremo giratorio de la herramienta.
- Anticipe y esté atento a los cambios repentinos en el movimiento durante la puesta en marcha y utilización de toda herramienta motorizada.
- Mantenga una postura del cuerpo equilibrada y firme. No estire demasiado los brazos al manejar la herramienta. Pueden darse elevados pares de reacción a la presión de aire recomendada, e incluso a presiones inferiores.
- El eje de la herramienta puede seguir girando brevemente después de haberse soltado el mando.
- Las herramientas neumáticas pueden vibrar durante el uso. La vibración, los movimientos repetitivos o las posiciones incómodas pueden dañarle los brazos y manos. En caso de incomodidad, sensación de hormigueo o dolor, deje de usar la herramienta. Consulte con el médico antes de volver a utilizarla.
- Utilice únicamente los accesorios Ingersoll-Rand recomendados.
- Esta herramienta no ha sido diseñada para trabajar en ambientes explosivos.
- Esta herramienta no está aislada contra descargas eléctricas.

NOTA

El uso de piezas de recambio que no sean las auténticas piezas Ingersoll-Rand puede poner en peligro la seguridad, reducir el rendimiento de la herramienta y aumentar los cuidados de mantenimiento necesarios, así como invalidar toda garantía.

Las reparaciones sólo se deben encomendar a personal debidamente cualificado y autorizado. Consulte con el centro de servicio autorizado Ingersoll-Rand más próximo.

Toda comunicación se deberá dirigir a la oficina o al distribuidor Ingersoll-Rand más próximo.

© Ingersoll-Rand Company 1996

Impreso en EE. UU.

INGERSOLL-RAND®
PROFESSIONAL TOOLS

ETIQUETAS DE AVISO

⚠ AVISO

EL HACER CASO OMISO DE LOS AVISOS SIGUIENTES PODRÍA OCASIONAR LESIONES.



⚠ ADVERTENCIA
Usar siempre protección ocular al manejar o realizar operaciones de mantenimiento en esta herramienta.



⚠ ADVERTENCIA
Usar siempre protección para los oídos al manejar esta herramienta.



⚠ ADVERTENCIA
Cortar siempre el suministro de aire y desconectar la manguera de suministro de aire antes de instalar, retirar o ajustar cualquier accesorio de esta herramienta, o antes de realizar cualquier operación de mantenimiento de la misma.



⚠ ADVERTENCIA
Las herramientas neumáticas pueden vibrar durante el uso. La vibración, los movimientos repetitivos o las posiciones incómodas podrían dañarle los brazos y las manos. En caso de incomodidad, sensación de hormigueo o dolor, dejar de usar la herramienta. Consultar al médico antes de volver a utilizarla.



⚠ ADVERTENCIA
No coger la herramienta por la manguera para levantarla.



⚠ ADVERTENCIA
No utilizar mangueras de aire y accesorios dañados, desgastados ni deteriorados.



⚠ ADVERTENCIA
Mantener una postura del cuerpo equilibrada y firme. No estirar demasiado los brazos al manejar la herramienta.



⚠ ADVERTENCIA
Manejar la herramienta a una presión de aire máxima de 90 psig (6,2 bar/620 kPa).

Etiqueta de Aviso Internacional:
Pida Pieza No. _____

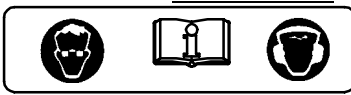

PARA PONER LA HERRAMIENTA EN SERVICIO

LUBRICACIÓN



Ingersoll-Rand N° 50

Utilice siempre un lubricador de aire comprimido con esta herramienta. Recomendamos utilizar el siguiente conjunto de filtro-lubricador-regulador:

C26-C4-A29

Después de cada ocho horas de funcionamiento, salvo que se utilice un lubricador de aire comprimido, inyecte 1/2 cc de aceite Ingersoll-Rand N° 50 en la admisión de aire antes de conectar la manguera.

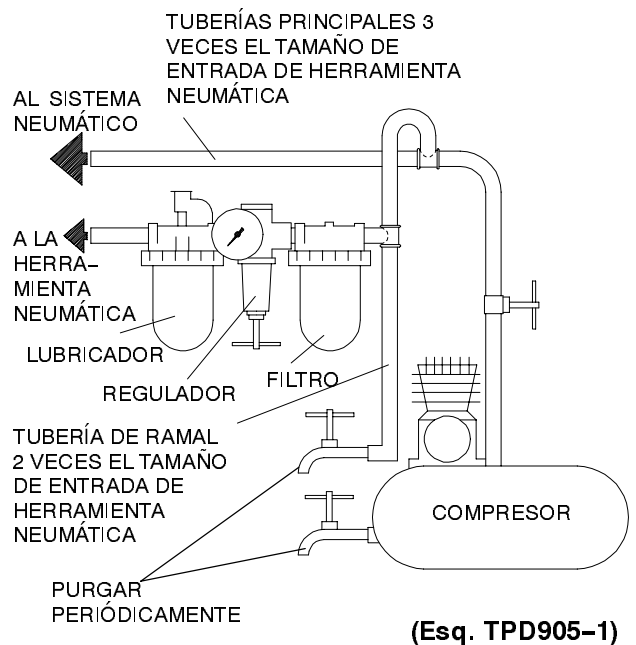

ESPECIFICACIONES

| Modelo | Tipo de empuñadura | Tamaño de pinza | | Velocidad en vacío | ■ Nivel de sonido dB (A) | | ◆ Nivel de vibraciones m/s ² |
|----------|--------------------|-----------------|----|--------------------|--------------------------|-----------|---|
| | | pulg. | mm | | Presión | •Potencia | |
| LA419-EU | Palanca | 1/4 | 6 | 25 000 | 89.8 | 102.8 | 4,4 |

- Probado en conformidad con ANSI S5.1-1971 a velocidad libre
- ◆ Probado en conformidad con ISO8662-1 con carga desequilibrada artificial a 50% de la velocidad nominal para las herramientas sin reguladores y a 80% de la velocidad libre nominal para las herramientas reguladas.

• ISO3744

INSTRUCTIES VOOR TYPE LA419-EU STIFTSLIJPMACHINE MET 1/4" SPANTANG VOOR EXTRA ZWAAR WERK

LET WEL

Het Type LA419-EU Stiftslijpmachine is een compacte Slijpmachine voor algemeen gebruik bedoeld voor het polijsten van banden, afwerken van metalen en bewerken van lasverbindingen in beperkte ruimten.

Ingersoll-Rand is niet aansprakelijk voor door de klant aangebrachte veranderingen aan de gereedschappen voor toepassingen waarover met Ingersoll-Rand geen voorafgaand overleg werd gepleegd.

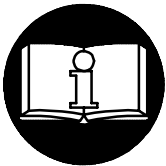

⚠ WAARSCHUWING

BELANGRIJKE VEILIGHEIDSINFORMATIE IS INGESLOTEN.

EERST DIT HANDBOEK LEZEN, DAN HET GEREEDSCHAP BEDIENEN.

HET BEHOORT TOT DE VERANTWOORDELIJKHEID VAN DE WERKGEVER DE IN DIT HANDBOEK GEGEVEN INFORMATIE AAN DE GEBRUIKER TER HAND TE STELLEN.

EEN NALATEN DE HIERNAVOLGENDE WAARSCHUWINGEN OP TE VOLGEN KAN LICHAMELIJK LETSEL TOT GEVOLG HEBBEN.

INGEBRUIKNEMING VAN HET GEREEDSCHAP

- Dit gereedschap altijd bedienen, controleren en onderhouden in overeenstemming met alle voorschriften (plaatselijk, staat, federaal en land), die betrekking hebben op hand-gehouden/hand-bediende pneumatische gereedschappen.
- Voor veiligheid, topprestatie, en maximale bestendigheid van de onderdelen dit gereedschap laten werken bij een maximale luchtdruk van 90 psig (6.2 bar/620 kPa) bij de inlaat met een luchttoevoerslang, die een inwendige diameter van 3/8" (10 mm) heeft.
- Men dient te allen tijde de luchtinlaat af te sluiten en de luchttoevoerslang te ontkoppelen voordat enig deel aan dit gereedschap wordt aangebracht, verwijderd of afgesteld, of voordat enig onderhoud aan dit gereedschap mag worden uitgevoerd.
- Geen beschadigde, gerafelde of versleten luchtslangen of fittingen gebruiken.
- Zorg ervoor dat alle slangen en fittingen de juiste afmetingen hebben en goed zijn vastgemaakt. Zie tekening TPD905-1 voor een typisch leidingnet.
- Altijd schone, droge lucht gebruiken bij een maximum luchtdruk van 90 psig. Stof, corroderende uitwasemingen en/of te grote vochtigheid kunnen de motor van een drukluchtgereedschap ruïneren.
- De gereedschappen niet smeren met ontvlambare of vluchtige vloeistoffen als petroleum, diesel of (straal) vliegtuigbrandstoffen.
- Geen typeplaatjes verwijderen. Beschadigde typeplaatjes moeten worden vervangen.

GEBRUIK VAN HET GEREEDSCHAP

- U moet te allen tijde oogbeschermers dragen wanneer u dit gereedschap bedient of er onderhoudswerkzaamheden aan uitvoert.
- Altijd oorbeschermers dragen wanneer dit gereedschap wordt bediend.
- Houd handen, losse kleding of lang haar weg van het draaiende eind van het gereedschap.
- Let op en anticipeer op plotselinge veranderingen in de werking van enig persluchtgereedschap zowel tijdens de start als gedurende het in bedrijf zijn.
- Steeds in een goede houding staan. Als u het gereedschap bedient mag u zich niet te ver uitstrekken. Hoge reactiekoppels kunnen voorkomen bij of beneden de aanbevolen luchtdruk.
- De as van het gereedschap kan even blijven draaien nadat de bediening is losgelaten.
- Persluchtgereedschappen kunnen tijdens gebruik ervan trillen. Trillingen, zich herhalende bewegingen, of ongemakkelijke houdingen kunnen schadelijk zijn voor uw handen en armen. Stop met bediening van enig gereedschap wanneer u ongemak, een tintelend gevoel of pijn ervaart. Zoek medisch advies alvorens het werk te hervatten.
- Uitsluitend de door Ingersoll-Rand aanbevolen bijbehorende hulpstukken gebruiken.
- Dit gereedschap is niet ontworpen om er mee in explosieve omgevingen te werken.
- Dit gereedschap is niet geïsoleerd tegen elektrische schokken.

LET WEL

Het gebruiken van andere dan originele Ingersoll-Rand onderdelen kan gevaar opleveren voor de veiligheid, en een vermindering met zich brengen van het prestatievermogen van het gereedschap en een toeneming van het onderhoud ervan; het kan een vervallen van alle garantie-bepalingen tot gevolg hebben.

Reparaties mogen uitsluitend worden uitgevoerd door hiertoe gemachtigd en geschoold personeel. Raadpleeg uw dichtstbijzijnde erkende Ingersoll-Rand Servicenter.

LABELS MET WAARSCHUWINGSINSTRUCTIES

⚠ WAARSCHUWING

EEN NALATEN DE HIERNAVOLGENDE WAARSCHUWINGEN OP TE VOLGEN KAN LICHAAMELIJK LETSEL TOT GEVOLG HEBBEN.



⚠ WAARSCHUWING
U moet te allen tijde oogbeschermers dragen wanneer u dit gereedschap bedient of er onderhoudswerkzaamheden aan uitvoert.



⚠ WAARSCHUWING
Altijd oorbeschermers dragen wanneer dit gereedschap wordt bediend.

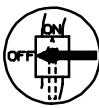

⚠ WAARSCHUWING
Men dient te allen tijde de luchtinlaat af te sluiten en de luchttoevoerslang te ontkoppelen voordat enig deel aan dit gereedschap wordt aangebracht, verwijderd of afgesteld, of voordat enig onderhoud aan dit gereedschap mag worden uitgevoerd.



⚠ WAARSCHUWING
Persluchtgereedschappen kunnen tijdens gebruik ervan trillen. Trillingen, zich herhalende bewegingen, of ongemakkelijke houdingen kunnen schadelijk zijn voor uw handen en armen. Stop met bediening van enig gereedschap wanneer u ongemak, een tintelend gevoel of pijn ervaart. Zoek medisch advies alvorens werk te hervatten.



⚠ WAARSCHUWING
Het gereedschap niet aan de slang dragen.



⚠ WAARSCHUWING
Geen beschadigde, gerafelde of versleten luchtslangen of fittingen gebruiken.



⚠ WAARSCHUWING
Steeds in een goede houding staan. Als u het gereedschap bedient mag U zich niet te ver uitstrekken.



⚠ WAARSCHUWING
Bedienen tot een maximum luchtdruk van 90 psig (6.2 bar/620 kPa).

Internationale waarschuwingslabel:
Bestel onderdeel nr. _____

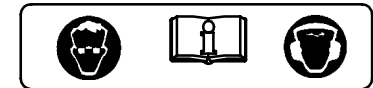

INGEBRUIKNEMING VAN HET GEREEDSCHAP

DE SMERING



Ingersoll-Rand Nr. 50

Men moet steeds een in-lijn aangesloten drukluchtsmeerinrichting gebruiken. Wij bevelen u de volgende Filter-Smeerinrichting-Regeleenheid aan:

C26-C4-A29

Na elke acht bedrijfsuren, tenzij een in-lijn olienevelaar wordt gebruikt, voordat de slang wordt aangebracht eerst 1/2 cc Ingersoll-Rand Nr. 50 Olie in de Luchtinlaat spuiten.

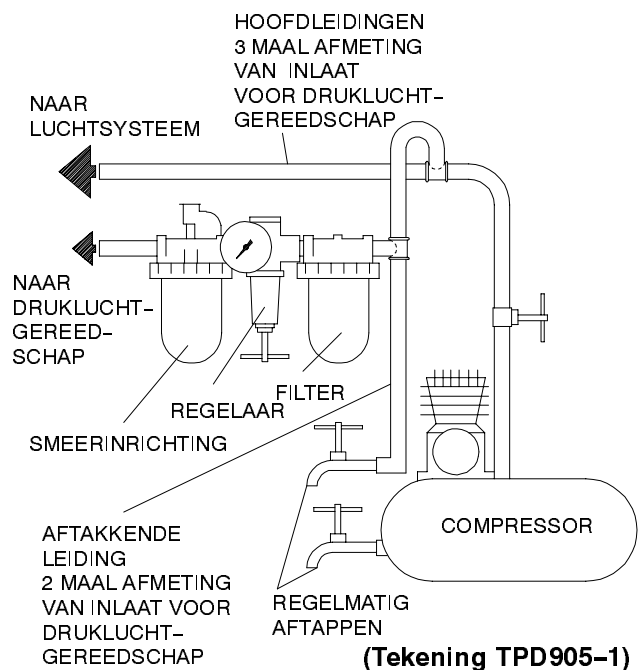

SPECIFICATIES

| Type | Soort hendel | Afmeting spantang | | Onbelast toerental | ■ Geluidsniveau dB (A) | | ◆ Trillingsniveau m/s ² |
|----------|--------------|-------------------|----|--------------------|------------------------|------------|------------------------------------|
| | | in | mm | | Deuk | • Vermogen | |
| LA419-EU | hefboom | 1/4" | 6 | 25 000 | 89.8 | 102.8 | 4,4 |

- Getest volgens ANSI S5.1-1971 bij vrije snelheid
- ◆ Getest volgens ISO8662-1 met kunstmatige onevenwichtige belasting van 50% van de nominale snelheid voor onbestuurde werkuigen en 80% van de nominale vrije snelheid voor bestuurde werktuigen.
- ISO3744

SCHRIFTELIJKE VERKLARING VAN CONFORMITEIT

Wij Ingersoll-Rand, Co.
(naam leverancier)

Swan Lane, Hindley Green, Wigan WN2 4EZ
(adres)

verklaren, onder onze uitsluitende aansprakelijkheid, dat het produkt:

Type LA419-EU Stijflijpmachine met 1/4" Spantang voor Extra Zwaar Werk

waarop deze verklaring betrekking heeft overeenkomt met de bepalingen van directieven:

89/392/EEC, 91/368/EEC, 93/44/EEC, 93/68/EEC

overeenkomstig de volgende hoofdstandaards: ISO8662

Serienummers: (1994 →) XUA XXXXX →

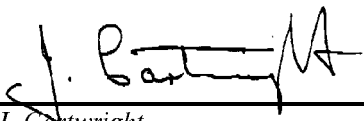
J. Cartwright
Naam en handtekening van gemachtigde personen

Chuck S. Zegrati
Name and signature of authorised persons

Februari, 1995
Datum

February, 1995
Date

LET WEL

DEZE INSTRUCTIES GOED BEWAREN. NIET Vernietigen.

Wanneer de levensduur van het gereedschap verstreken is, wordt u aangeraden het gereedschap te demonteren en ontvetten, en de delen gescheiden naar materialen op te bergen zodat zij gerecycled kunnen worden.

**MAINTENANCE INSTRUCTIONS
SECTION D'ENTRETIEN
WARTUNG
SEZIONE DI MANUTENZIONE
INSTRUCCIONES DE MANTENIMIENTO
ONDERHOUD**

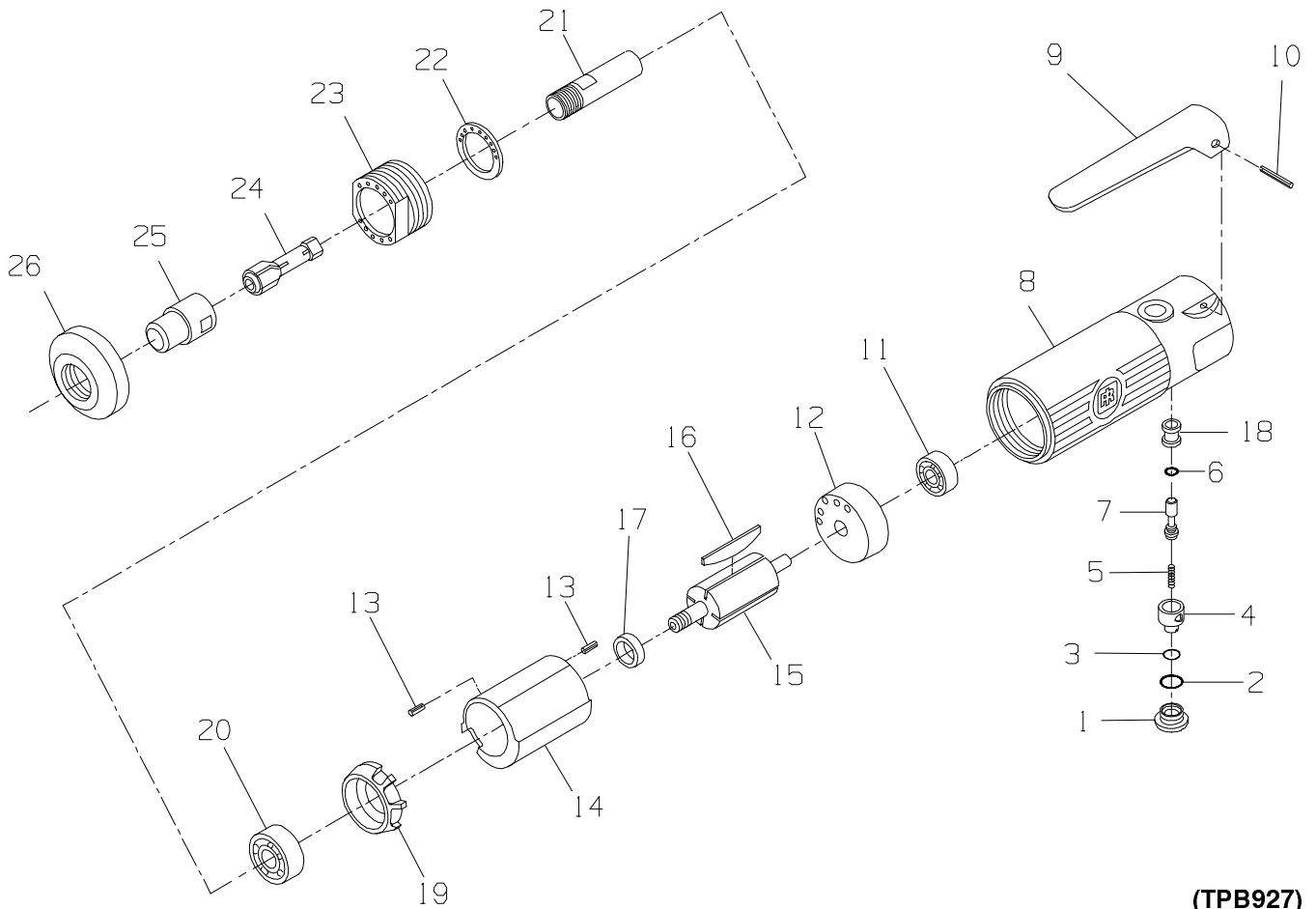

(TPB927)

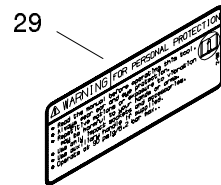
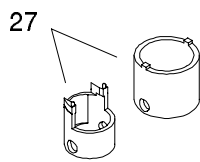

PART NUMBER FOR ORDERING
REFERENCE POUR COMMANDE DE LA PIECE
BESTELNUMBER
NUMERO DEL PEZZO PER L'ORDINAZIONE
SIMBOLO DE LA PIEZA PARA PEDIDOS
BESTELNUMMERS



| | | | | | |
|----|-----------|----|--------------|----|-----------|
| 1 | LA419-266 | 11 | LA419-22 | 21 | LA419-214 |
| 2 | LA419-1 | 12 | LA419-12 | 22 | LA419-311 |
| 3 | LA419-2 | 13 | LA419-98 (2) | 23 | LA419-27 |
| 4 | LA419-4 | 14 | LA419-3 | 24 | LA419-700 |
| 5 | LA419-274 | 15 | LA419-53 | 25 | LA419-698 |
| 6 | LA419-6 | 16 | LA419-42 (4) | 26 | LA419-699 |
| 7 | LA419-302 | 17 | LA419-17 | 27 | LA419-69 |
| 8 | LA419-40 | 18 | LA419-503 | 28 | LA419-301 |
| 9 | LA419-273 | 19 | LA419-11 | 29 | EU-99 |
| 10 | LA419-120 | 20 | LA419-24 | | |

**Service Centers
Centres d'entretien
Ingersoll-Rand Niederlassungen
Centri di Assistenza
Centros de Servicio
Service Centra**



Ingersoll-Rand Company – 510 Hester Drive –
White House, TN 37188 – USA

Ingersoll-Rand Sales Company Limited
Chorley New Road
Horwich, Bolton
Lancashire BL6 6JN
England – UK
Tel: (44) 1204 880890
Fax: (44) 1204 880388

Ingersoll-Rand Equipements de Production
111 Avenue Roger Salongro
BP 59
F-59450 Sin Le Noble
France
Tel: (33) 27 93 0808
Fax: (33) 27 93 0800

Ingersoll-Rand GmbH
Gewerbeallee 17
45478 Mülheim/Ruhr
Deutschland
Tel: (49) 208 99940
Fax: (49) 208 9994445

Ingersoll-Rand Italiana SpA
Casella Postale 1232
20100 Milano
Italia
Tel: (39) 2 950561
Fax: (39) 2 95380169

Ingersoll-Rand
Camino de Rejas 1, 2-18 B1S
28820 Coslada (Madrid)
España
Tel: (34) 1 669 5850
Fax: (34) 1 669 6054

Ingersoll-Rand Nederland
Produktieweg 10
2382 PB Zoeterwoude
Nederland
Tel: (31) 71 452200
Fax: (31) 71 218671

Ingersoll-Rand Company SA
PO Box 3720
Alrode 1451
South Africa
Tel: (27) 11 864 3930
Fax: (27) 11 864 3954

Ingersoll-Rand
Scandinavian Operations
Kastruplundgade 221
DK-2770 Kastrup
Danmark
Tel: (45) 32 526092
Fax: (45) 32 529092

Ingersoll-Rand SA
The Alpha Building
Route des Arsenaux 9
CH-1700 Fribourg
Schweiz/Suisse
Tel: (41) 37 205111
Fax: (41) 37 222932

Ingersoll-Rand Company
Kuznetsky Most 21/5
Entrance 3
103698 Moscow
Russia
CIS
Tel: (7) 501 882 0440
Fax: (7) 501 882 0441

Ingersoll-Rand Company
16 Pietro
Ul Stawki 2
PL-00193 Warsaw
Poland
Tel: (48) 2 635 7245
Fax: (48) 2 635 7332

INSTRUÇÕES PARA ESMERILADORA DIE PARA TRABALHOS PESADOS COM PINÇA DE 1/4" MODELO LA419-EU

AVISO

A Esmeriladora Modelo LA419-EU é uma ferramenta compacta de aplicação geral para alisamento de pneus, acabamento de metais e alisamento de solda em áreas confinadas. A Ingersoll-Rand não é responsável por modificações, feitas pelo cliente em ferramentas, nas quais a Ingersoll-Rand não tenha sido consultada.

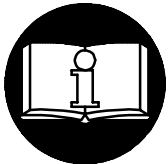

⚠️ ADVERTÊNCIA

**INFORMAÇÃO DE SEGURANÇA IMPORTANTE EM ANEXO.
LEIA ESTE MANUAL ANTES DE OPERAR A FERRAMENTA.
É DA RESPONSABILIDADE DO EMPREGADOR COLOCAR A INFORMAÇÃO
DESTE MANUAL NAS MÃOS DO OPERADOR.
O NÃO CUMPRIMENTO DAS SEGUINTE ADVERTÊNCIAS PODE
RESULTAR EM FERIMENTOS.**

COLOCANDO A FERRAMENTA EM FUNCIONAMENTO

- Opere, inspecione e mantenha sempre esta ferramenta de acordo com todas regulamentações (local, estadual, federal e do país), que possam ser aplicadas às ferramentas pneumáticas operadas manualmente ou seguras com as mãos.
- Para segurança, máximo desempenho e máxima durabilidade das peças, opere esta ferramenta com uma pressão de ar máxima de 6,2 bar/620 kPa (90 psig) na entrada da mangueira de alimentação de ar com diâmetro interno de 10 mm (3/8").
- Desligue sempre a alimentação de ar e desconecte a mangueira de alimentação de ar antes de instalar, remover ou ajustar qualquer acessório nesta ferramenta, ou antes de executar qualquer serviço de manutenção nesta ferramenta.
- Não use mangueiras de ar ou adaptadores danificados, gastos ou deteriorados.
- Certifique-se de que todas as mangueiras e adaptadores sejam do tamanho correcto e estejam apertados com firmeza. Veja o Desenho TPD905-1 para um arranjo típico de tubagem.
- Use sempre ar seco e limpo com pressão máxima de 90 psig. Pó, fumos corrosivos e/ou humidade excessiva podem arruinar o motor de uma ferramenta pneumática.
- Não lubrifique as ferramentas com líquidos inflamáveis ou voláteis tais como querosene, diesel ou combustível de jactos.
- Não remova nenhum rótulo. Reponha qualquer rótulo danificado.

USANDO A FERRAMENTA

- Use sempre óculos de protecção quando estiver operando ou executando serviço de manutenção nesta ferramenta.
- Use sempre protecção contra ruído ao operar esta ferramenta.
- Mantenha as mãos, partes do vestuário soltas e cabelos compridos afastados da extremidade em rotação.
- Antecipe e esteja alerta a mudanças repentinas no movimento quando ligar e operar qualquer ferramenta motorizada.
- Mantenha a posição do corpo equilibrada e firme. Não exagere quando operar esta ferramenta. Torques de reacção elevados podem ocorrer na ou abaixo da pressão de ar recomendada.
- O eixo da ferramenta pode continuar a girar brevemente após a pressão ter sido aliviada.
- Ferramentas accionadas pneumáticamente podem vibrar em uso. Vibração, movimentos repetitivos ou posições desconfortáveis podem ser prejudiciais às mãos e aos braços. Pare de usar a ferramenta caso ocorra algum desconforto, sensação de formigueiro ou dor. Procure assistência médica antes de retornar ao trabalho.
- Use acessórios recomendados pela Ingersoll-Rand.
- Esta Ferramenta não foi concebida para trabalhos em atmosferas explosivas.
- Esta Ferramenta não está isolada contra choques eléctricos.

AVISO

O uso de peças de substituição que não sejam genuinamente da Ingersoll-Rand podem resultar em riscos de segurança, diminuição do desempenho da ferramenta, aumento da necessidade de manutenção e pode invalidar todas as garantias. As reparações devem ser feitas somente por pessoal treinado autorizado. Consulte o Centro de Serviços da Ingersoll-Rand mais próximo.

IDENTIFICAÇÃO DO RÓTULO DE ADVERTÊNCIA

⚠ ADVERTÊNCIA

O NÃO CUMPRIMENTO DAS SEGUINTE ADVERTÊNCIAS PODE RESULTAR EM FERIMENTOS.



⚠ ADVERTÊNCIA
Use sempre óculos de protecção quando estiver operando ou executando algum serviço de manutenção nesta ferramenta.



⚠ ADVERTÊNCIA
Use sempre protecção contra o ruído ao operar esta ferramenta.



⚠ ADVERTÊNCIA
Desligue sempre a alimentação de ar e desconecte a mangueira de alimentação de ar antes de instalar, remover ou ajustar qualquer acessório nesta ferramenta, ou antes de executar algum serviço de manutenção nesta ferramenta.



⚠ ADVERTÊNCIA
Ferramentas accionadas pneumáticamente podem vibrar em uso. Vibração, movimentos repetitivos ou posições desconfortáveis podem ser prejudiciais às mãos e aos braços. Pare de usar a ferramenta caso ocorra algum desconforto, sensação de formigamento ou dor. Procure assistência médica antes de retornar ao trabalho.



⚠ ADVERTÊNCIA
Não carregue a ferramenta segurando na mangueira.



⚠ ADVERTÊNCIA
Não use mangueiras de ar ou adaptadores danificados, gastos ou deteriorados.





⚠ ADVERTÊNCIA
Mantenha a posição do corpo equilibrada e firme. Não exagere quando operar esta ferramenta. Torques de reacção elevados podem ocorrer sob a pressão de ar recomendada.



⚠ ADVERTÊNCIA
Opere com pressão do ar Máxima de 90-100 psig (6,2-6,9 bar).

Rótulo de Advertência Internacional No. de Referência para Pedido

COLOCANDO A FERRAMENTA EM FUNCIONAMENTO

LUBRIFICAÇÃO



Ingersoll-Rand No. 50

Use sempre um lubrificador de ar de linha com estas ferramentas. Nós recomendamos a seguinte unidade Filtro-Lubrificador-Regulador:

C26-C4-A29

Depois de oito horas de operação, a menos que um lubrificador de ar de linha estiver sendo usado, injecte 1/2 cc de Óleo Ingersoll-Rand No. 50 na entrada de ar antes de ligar a mangueira.

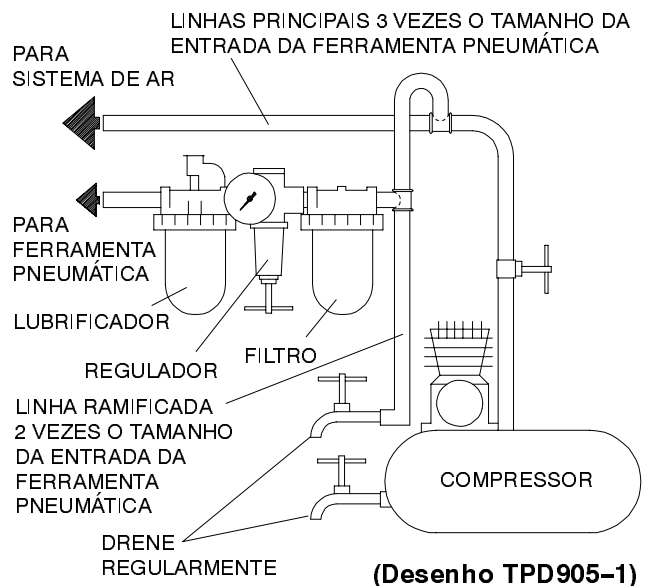

ESPECIFICAÇÕES

| Model | Tipo de Punho | Comprimento da Pinça | | Velocidade Livre rpm | ■ Nível de Ruído dB (A) | | ◆ Nível de Vibrações m/s ² |
|----------|---------------|----------------------|------|-------------------------|----------------------------|-----------|--|
| | | mm | pol. | | Pressão | •Potencia | |
| LA419-EU | alavanca | 6 | 1/4 | 25 000 | 89,8 | 102,8 | 4,4 |

- Testada de acordo com a ANSI S5.1-1971 com velocidade livre
- ◆ Testada de acordo com a ISO8662-1 com uma carga não balanceada artificial com 50% da velocidade estimada para ferramentas desgobernadas e com 80% da velocidade para ferramentas gobernadas.
- ISO3744

DECLARAÇÃO DE CONFORMIDADE

Nós Ingersoll-Rand, Co.
(nome do fornecedor)

Swan Lane, Hindley Green, Wigan WN2 4EZ
(endereço)

declaramos sobre nossa única responsabilidade que o produto,

Esmeriladora Die para Trabalhos Pesados com Pinça de 1/4"
Modelo LA419-EU

ao(s) qual(is) esta declaração se refere, está (ão) de acordo com as provisões da
Directivas 89/392/EEC, 91/368/EEC, 93/44/EEC e 93/68/EEC

Ao se utilizar os seguintes Princípios Standards: ISO8662

Intervalo de Número de Série: (1994 →) XUA XXXXX →

J. Cartwright
Nome e assinatura das pessoas autorizadas

Chuck S. Zegrati
Nome e assinatura das pessoas autorizadas

Maio de 1995
Data

Maio de 1995
Data

AVISO

GUARDE ESTAS INSTRUÇÕES. NÃO AS DESTRUA.

Quando a duração de uma ferramenta expirar, recomenda-se que a mesma seja desmontada, desengraxada e que as peças sejam agrupadas conforme seu material e assim possam ser recicladas.

INSTRUÇÕES DE MANUTENÇÃO

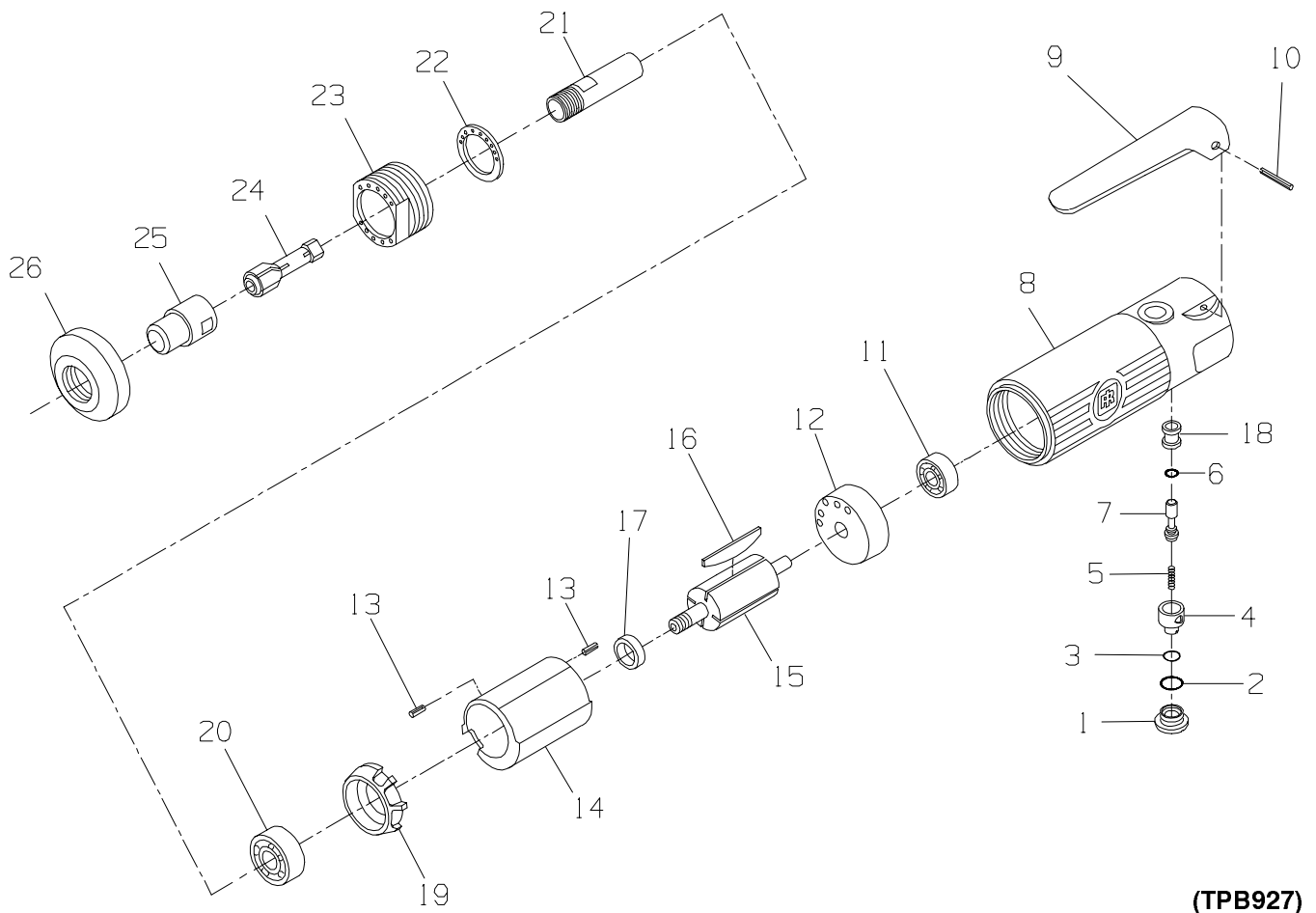

(TPB927)

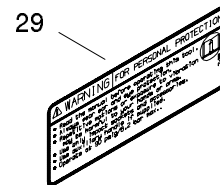
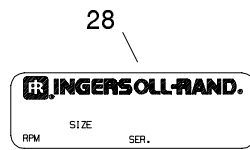
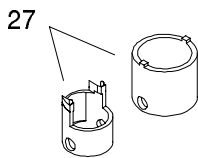

NÚMERO DA PEÇA PARA ENCOMENDAS



| | | | | | |
|----|-----------|----|--------------|----|-----------|
| 1 | LA419-266 | 11 | LA419-22 | 21 | LA419-214 |
| 2 | LA419-1 | 12 | LA419-12 | 22 | LA419-311 |
| 3 | LA419-2 | 13 | LA419-98 (2) | 23 | LA419-27 |
| 4 | LA419-4 | 14 | LA419-3 | 24 | LA419-700 |
| 5 | LA419-274 | 15 | LA419-53 | 25 | LA419-698 |
| 6 | LA419-6 | 16 | LA419-42 (4) | 26 | LA419-699 |
| 7 | LA419-302 | 17 | LA419-17 | 27 | LA419-69 |
| 8 | LA419-40 | 18 | LA419-503 | 28 | LA419-301 |
| 9 | LA419-273 | 19 | LA419-11 | 29 | EU-99 |
| 10 | LA419-120 | 20 | LA419-24 | | |

Centro de Serviço



Ingersoll-Rand Company - 510 Hester Drive -
White House, TN 37188 - USA

Ingersoll-Rand Sales Company Limited
Chorley New Road
Horwich, Bolton
Lancashire BL6 6JN
England - UK
Tel: (44) 1204 880890
Fax: (44) 1204 880388

Ingersoll-Rand Equipements de Production
111 Avenue Roger Salongro
BP 59
F-59450 Sin Le Noble
France
Tel: (33) 27 93 0808
Fax: (33) 27 93 0800

Ingersoll-Rand GmbH
Gewerbeallee 17
45478 Mülheim/Ruhr
Deutschland
Tel: (49) 208 99940
Fax: (49) 208 9994445

Ingersoll-Rand Italiana SpA
Casella Postale 1232
20100 Milano
Italia
Tel: (39) 2 950561
Fax: (39) 2 95380169

Ingersoll-Rand
Camino de Rejas 1, 2-18 B1S
28820 Coslada (Madrid)
España
Tel: (34) 1 669 5850
Fax: (34) 1 669 6054

Ingersoll-Rand Nederland
Produktieweg 10
2382 PB Zoeterwoude
Nederland
Tel: (31) 71 452200
Fax: (31) 71 218671

Ingersoll-Rand Company SA
PO Box 3720
Alrode 1451
South Africa
Tel: (27) 11 864 3930
Fax: (27) 11 864 3954

Ingersoll-Rand
Scandinavian Operations
Kastruplundgade 221
DK-2770 Kastrup
Danmark
Tel: (45) 32 526092
Fax: (45) 32 529092

Ingersoll-Rand SA
The Alpha Building
Route des Arsenaux 9
CH-1700 Fribourg
Schweiz/Suisse
Tel: (41) 37 205111
Fax: (41) 37 222932

Ingersoll-Rand Company
Kuznetsky Most 21/5
Entrance 3
103698 Moscow
Russia
CIS
Tel: (7) 501 882 0440
Fax: (7) 501 882 0441

Ingersoll-Rand Company
16 Pietro
Ul Stawki 2
PL-00193 Warsaw
Poland
Tel: (48) 2 635 7245
Fax: (48) 2 635 7332