

**SIMPLY PRODUCTIVE**  
WITH CONNECTIVITY.



**QX SERIES™**  
**CORDLESS PRECISION FASTENING SYSTEMS**



# QX CONNECT SERIES™

Taking total control of your fastening process doesn't have to be complicated. Our comprehensive QX Connect Series™ family of fastening systems deliver simple, flexible and capable solutions for all of your assembly requirements. No matter the industry or application, you can count on Ingersoll Rand as a trusted partner to help you get the job done right.



## TABLE OF CONTENTS

- QX Connect Series™ Cordless Precision Fastening Systems Overview 4
- QX Connect Series™ features 5
- How to select the right tool 6
- QXF Series Cordless Tools 7
- QXB Series Cordless Tools 8
- QXX Series Cordless Tools 9
- QXW Limitless Series Cordless Tools 10
- QX Connect ETS Series Cordless Tools 12
- Customize for special applications 13
- QXM Series Cordless Torque Multiplier 14
  - Adaptable to your application 15
  - QXM Series Cordless Torque Multiplier Features 16
  - Superior control and communication 17
  - Reaction arms for multipliers 18
- System accessories 19
- INSIGHT™ Connect app 20
- INSIGHTQCX™ Cordless Controller 21
  - Control Multiple Tools with 1 Controller (with MTC option) 22
  - Models 23
  - Capabilities 24
  - Specifications 25
- INSIGHTQCT™ Series 26
  - Calibration Equipment 26
  - Torque Testers and Analyzers 28
- QX Connect technical specifications 30

## DIFFERENT, BY DESIGN

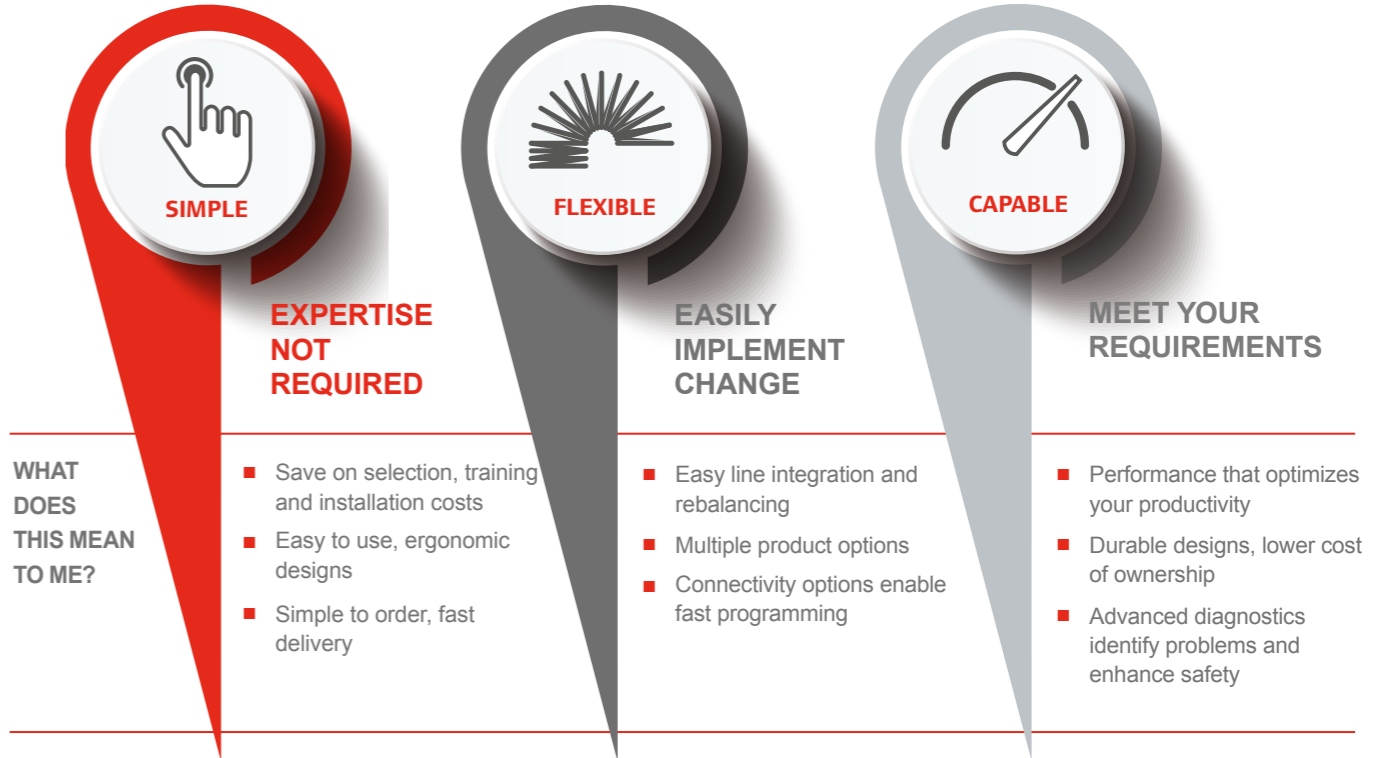

### ICON IDENTIFIERS

- Compatibility Reference
- USB compatible
- Insight Connect App
- ETS (Ergonomic Tightening System)
- Wireless
- Bluetooth compatible

# QX CONNECT SERIES™ CORDLESS PRECISION FASTENING SYSTEMS OVERVIEW

The innovative QX Connect Series™ is simple for anyone to use. It offers flexibility because of its feature-rich configurations, and can manage everything from data and fast programming to modifications on your line. The QX Connect Series™ increases productivity and lowers costs — all at a price you can afford.

## SIMPLE

- Multi-function display module for quick setup and feedback
- Compact, lightweight and ergonomically balanced so the operator can work without restraints
- The intuitive INSIGHT Connect app will help you stay productive & mobile on the plant floor via Bluetooth or wired connection.

## FLEXIBLE

- Provides up to 32 fully programmable configurations on a single tool, reducing costs and workspace clutter
- Fast and intuitive programming makes the tool easily adaptable to any needed changes on your assembly line
- Cordless and portable, allowing for effortless movement around your facility

32

## CAPABLE

- At the heart of every tool is the closed-loop transducer control that delivers precise torque and accurate, traceable results
- Available in a variety of configurations, including pistol grip, angle wrench, multiplied, and ETS
- Wireless & Bluetooth communication options enable flexible line integration, remote monitoring and simple system programming across a plant-wide network
- Manage cycle data, control the process, receive system status alerts and implement configuration adjustments in real time with INSIGHTQCX™ using Ethernet, Fieldbus and digital I/O



# QX CONNECT SERIES™ FEATURES

- Precision planetary gears for greater reliability
- Patented transducer control provides traceable results
- USB port for convenient programming and data transfer
- Bluetooth & wireless Connectivity options
- Optional wireless communications for process control and data collection
- Durable DC brushless motor tested beyond a million cycles
- Multiple drive choices 1/4" quick-change, 1/4" square drive, 3/8" square drive, and 1/2" square drive options available
- Super bright LED headlight with programmable on and off times. \*
- Non-contacting patented trigger and reverse switch for maximum durability
- Ergonomic design, comfortable, lightweight and balanced
- High strength, impact resistant lens guards against damage
- Optional backlit display offers quick setup and remarkable visual feedback
- Lithium ion battery provides maximum run time and portability
- Optional Drive Modes for Reduced Reaction (ETS)

\* Not available on all models



# HOW TO SELECT THE RIGHT TOOL

**When it comes to fastening, non-transducerized tools don't stand a chance.**

The QX Connect Series™ line of products give you closed-loop control of your fastening process, and the ease of mobility with different connectivity options. Each and every tool allows for programmable tightening strategies to deliver higher quality fastened joints and a level of control that is unmatched by other solutions. The diversity of the QX Series™ lineup offers a simple, flexible and capable solution for any fastening need.

	QXFN QXFD	QXBN QXBD	QXXN QXXD	QXWD
Programmable with ICS	✓	✓	✓	X
Programmable with INSIGHTQCX	✓	✓	✓	✓
Programmable with INSIGHT Connect App				
ETS Mode (Separate Part Number)	✓	✓	✓	✓
Bluetooth	X	✓	✓	✓
Wireless Radio	X	X	✓	✓
WLAN / Wi-Fi	X	X	X	✓
Communication Band	X	X	X	Dual Band 2.4-5GHz
Cybersecurity Authentication	X	X	X	✓
No. Of Psets	32	32	32	32
Torque Range	0.8-80 Nm	0.8-80 Nm	0.8-80 Nm	0.8-80 Nm

# QXF SERIES CORDLESS TOOLS

QXF offers superior transducerized control and operator feedback in a way that is easy to use and simple to setup. This unique series features 32 tightening configuration that can be programmed via USB using the INSIGHT Connect app. All QXF tools have no wireless communication and can only be programmed via USB using the INSIGHT Connect app.

As a best alternative to a clutch tool it is optimized for stand-alone quality critical applications with it's transducer, results memory and angle control to prevent joint misalignments and unusual issues.

## FEATURES

- Program 32 PSETs configurations into one tool
- Transducerized for precise torque measurement
- Closed-loop control of torque, speed and degrees of rotation
- Visual operator feedback using display screen and green and red lights
- Visual torque validation on display
- Programmable preventative maintenance alarms
- Maintenance indicator for troubleshooting and diagnostics
- 1200 cycles of data storage

## BENEFITS

- Simple to program via display & USB using the INSIGHT Connect app
- Comes with a Display and a No-display option

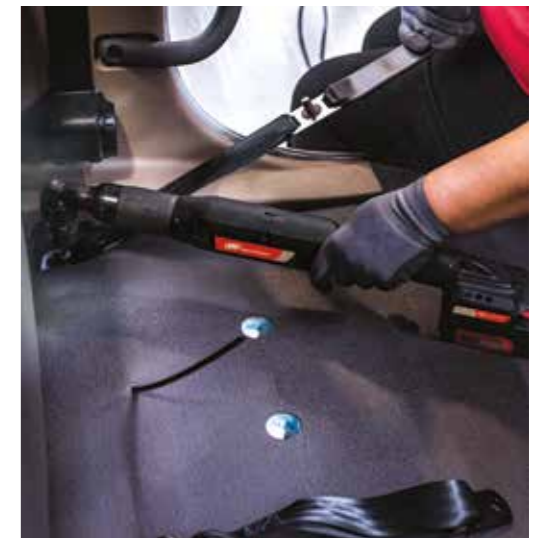

Visit [irtools.com/qx](http://irtools.com/qx) to view spec data and request a demo

# QXB SERIES CORDLESS TOOLS

The versatile QXB Series feature 32 tightening configurations, offering the ability to consolidate the number of tools needed in your bag or bench. The series also enhances the feedback provided from the tool by displaying the measured torque or angle results to the operator. The QXB models further add Bluetooth connectivity & program the tools via wireless using the INSIGHT™ Connect app.

As a best alternative to a clutch tool it is optimized for stand-alone quality critical applications with it's transducer, results memory and angle control to prevent joint misalignments and unusual issues. Additionally, flexibility of programming from any smartphone or tablet with INSIGHT App & Bluetooth. Versatile even in remote applications, where advanced settings and basic data collection is required.

## FEATURES

- Program 32 PSETs configurations into one tool
- Transducerized for precise torque measurement
- Closed-loop control of torque, speed and degrees of rotation
- Visual operator feedback using display screen and green and red lights
- Visual torque validation on display
- Programmable preventative maintenance alarms
- Maintenance indicator for troubleshooting and diagnostics
- 1200 cycles of data storage

## BENEFITS

- Simple to program via display & USB & bluetooth using the INSIGHT Connect app
- Comes with a Display and a No-display option



Visit [irtools.com/qx](http://irtools.com/qx) to view spec data and request a demo

# QXX SERIES CORDLESS TOOLS

The easy to use QXX has the unique ability to integrate with line control systems for error proofing and data collection. The series also allows remote monitoring and integration with standard fastening system accessories.

For applications where data collection, traceability and process control are critical to success, with easy to use interface for fast and flexible setup and integration.

## FEATURES

- Program 32 PSETs configurations into one tool
- Transducerized for precise torque measurement
- Closed-loop control of torque, speed and degrees of rotation
- Visual operator feedback using display screen and green and red lights
- Visual torque validation on display
- Programmable preventative maintenance alarms
- Maintenance indicator for troubleshooting and diagnostics
- 1200 cycles of data storage

## BENEFITS

- Simple to program via display & USB & bluetooth & zigbee using the INSIGHT Connect app or INSIGHT QCX Controller
- Comes with a Display and a No-display option
- Connect up to 6 Tools with INSIGHTQCX™ Controller



Visit [irtools.com/qx](http://irtools.com/qx) to view spec data and request a demo

# QXW LIMITLESS SERIES CORDLESS TOOLS

Ingersoll Rand's QX Connect Series™ has been instrumental in helping more organizations take control of their fastening processes through its simple, flexible, and capable performance. Now, with the introduction of the QXW Limitless platform we're adding 'connected, controlled, and compliant' to the bottom line. Dual-band communication technology deliver a seamless, uninterrupted connection - and across a greater communication range than other cordless fastening systems can offer.

## Connectivity • Complete Control • Confidently Secure

- Up to 10 Tools connected to Controller • Security Authentication
- Dual Band Communication • Extended Coverage on Mesh Networks



### SYSTEM Architecture

- Plant Network
- LAN Network
- WiFi Network



### FEATURES

- Program 32 PSETs configurations into one tool
- Transducerized for precise torque measurement
- Closed-loop control of torque, speed and degrees of rotation
- Visual operator feedback using display screen and green and red lights
- Visual torque validation on display
- Programmable preventative maintenance alarms
- Maintenance indicator for troubleshooting and diagnostics
- 1200 cycles of data storage

### BENEFITS

- Simple to program via display & USB & bluetooth & zigbee & wifi using the INSIGHT™ Connect App or INSIGHTQCX™ Controller
- Comes with Display
- Setup WIFI configuration using INSIGHT Net Desktop APP or INSIGHT™ Connect App
- Connect up to 10 Tools with INSIGHTQCX™ Controller
- 2.4 Ghz and 5Ghz Auto Switching
- Dual Band Communication 2.4Ghz and 5 Ghz
- Multiple Cybersecurity authentication

## WHY QXW Limitless?

### CONNECTIVITY

The QXW Limitless platform enhances seamless, plant-wide connectivity across a broader range where access points share the same SSID and password. Incorporating dual band communication technology, the system helps to eliminate communication breakdowns in high-traffic work zones to ensure no loss in production.

- Dual Band Communication seamlessly switches between 2.4 and 5 Ghz Band
- Reduces Limitation of Communication distance between Tools and Controller

### CONFIDENTLY SECURE

QXW Limitless delivers greater confidence, connecting with the devices you need and, just as importantly, NOT the ones you don't need. As a single product, it complies with multiple IT cybersecurity regulations, increasing data protection, restricting access to non-authorized devices, and providing ease of adoption across more systems.

### COMPLETE CONTROL

The QXW Limitless limits your hardware footprint by connecting more tools on a single platform. This fast, reliable system delivers greater control over more tools, delivering quick, complete data transfer between devices and reducing installation costs. Plus, your tools are ready for the next cycle much sooner, ensuring increased production efficiency.

- Connect Up to 10 Tools with INSIGHTQCX™ Controller
- Upto 40% reduction in Hardware footprint
- Faster data Transfer

### SPECIFICATIONS

Product Family	QXW
Torque Range	0.8-80 Nm
Tool Configuration	Pistol and Angle
Wireless Communication	WLAN + ZigBee + BLE
Band	2.4 and 5 Ghz (Dual Band)
Security Authentication	WPAWPA2, EAP-TLS, EAP TTLS, PEAP
Ergonomic Tightening System	Optional
Tool Display	Available
Communication Range	50 Meters + on 2.4 Ghz
Tools on INSIGHTQCX™	Upto 10 Tools



# QX CONNECT ETS SERIES CORDLESS TOOLS

Reducing the torque reaction in your fastening process doesn't have to be complicated. Control and ergonomics, not compromise - that is what the QX ETS is all about. The QX ETS offers all the capabilities found in the QX Connect Series™ platform, with less the torque reaction.

## What is ETS (Ergonomic Tightening System)

ETS stands for "Ergonomic Tightening System". QX + ETS delivers all the performance and control features of the standard QX Series™ precision fastening tools, with an improved ergonomic benefit. It significantly reduces the average amount of force experienced by the operator during the tightening process.



QX + ETS reduces average reaction force experienced by the QX Series™ user up to

**63%**

When ETS is active, the operator's arm movement is limited to a series of smaller movements instead of one large movement.

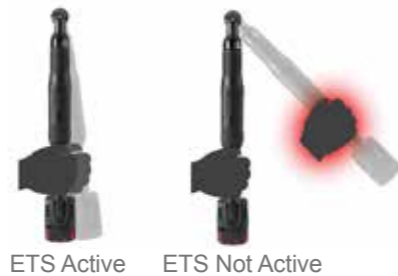

This enables the operator to stay in control and in the "power zone", reducing the chance for injury caused by quick, excessive movement.

## FEATURES

- Ergonomically enhanced motor control algorithm significantly reduces the average force experienced by the operator during the tightening process
- Red foot label provides clear indication of ETS tool identity vs standard QX tool
- Continuously flashing purple light above keypad provides operator assurance that ETS is ACTIVE
- All the capability of the QX platform, without the torque reaction
- Common software and battery platform for simple integration
- ETS features are available for all QX Connect models and available in pistol grip, low torque angle and high torque angle
- Onboard 'pulse' counter supports proper optimization and application of ETS tools on ideal applications (10 pulses or less per cycle)



## SIMPLE SETUP

In addition to standard direct drive mode, each tool configuration can be independently programmed to utilize one of the three available single-parameter ETS modes, simplifying setup:

### Ergonomic Mode

with the lowest energy pulses, is ideal for hard joints or when arm, wrist or tool angles are most difficult.

### Performance Mode

with medium energy pulses, is the best all-purpose mode.

### Productivity Mode

with the highest energy pulses, is the fastest mode. Ideal for soft joints or when high production rates are required.

# CUSTOMIZE FOR SPECIAL APPLICATIONS

## QX PISTOL SPECIAL HEAD ADAPTER

The QX Pistol Special Head Adapter is the perfect solution to simply increase the flexibility of your QX pistol screwdriver. Using this adapter leverages the closed-loop capability of the QX tool to the most unique applications. The adapter helps manufacturers meet the requirements of applications where restricted access requires a custom head to reach the fastener. Common applications requiring a special head adapter, include assembling aircraft wings or installing door hinges on cars and trucks.



**SIMPLE**  
Ready made and easy to install



**FLEXIBLE**  
Use your QX pistol grip tool for unique applications



**CAPABLE**  
Employ closed-loop control capabilities on specialty applications



## Special Head Adapter



**TK-VP1-550-S6**  
Standard 3/8" Square Drive Anglehead  
Max torque: 36 Nm

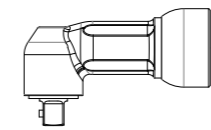

**TK-VP1-550-Q4**  
Standard 1/4" QC Drive Anglehead  
Max Torque : 36Nm

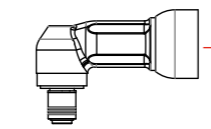

**TK-VP1-58**  
Standard 3/8" Square Drive Inline Floating Spindle with Flange Mount  
Max Torque : 24Nm

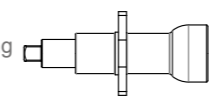

**Custom Attachment**  
Employ closed-loop control capabilities on specialty applications.

**VP1-K40**  
Special Head Adapter

Thrust washer  
Lock spacer

Any non-multiplier pistol grip QX tool

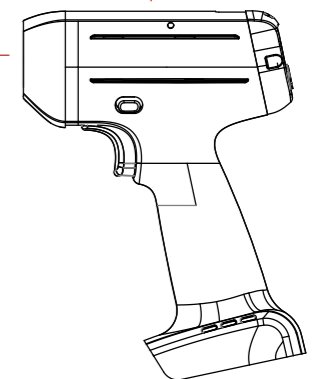

# QXM SERIES CORDLESS TORQUE MULTIPLIER

The next generation QX Series™ 40V Cordless Torque Multiplier, will reduce your bolting time and cost, while ensuring repeatable accuracy for all torque-critical joints. Designed with a premium gearbox and an efficient, time-tested closed-loop transducer, the Torque Multiplier offers proven quality, control and programmable configurations to maximize your productivity.

## TRACEABLE CONFIDENCE IN EVERY HIGH TORQUE FASTENING

### Accuracy

- Ingersoll Rand's closed-loop transducer control at the heart of the tool delivers precise torque and accurate, traceable results—it's precision where you need it most. Automatically trace every tightening cycle to the day and minute with a persistent internal clock. Forget manual pen and paper recording.

### Control

- A multi-function display module allowing for quick setup and real time feedback on every QX Series™ tool
- User-programmable configurations such as torque, angle and gang count that reduce the number of tools needed for multiple applications

### Comfort

- Cordless and compact, the QX Series™ Torque Multiplier allows operators to move freely without the need of bulky air or hydraulic hoses, electrical cords, compressors, generators or powerpacks
- Integrated tethering ring included to safely secure the tools

### Communication

- Program via USB, Bluetooth\* or Zigbee\*\* wireless connection (\*Requires mobile app (INSIGHT CONNECT) & QX Controller (INSIGHTQCX), controller sold separately)
- Direct connect the tool to the INSIGHT™ Connect app on your Bluetooth enabled device
- Tool configuration, data management and process control via INSIGHT™ Connect App

### Versatility

- Fast programming that makes the tool adaptable to multiple applications
- Cordless and portable to allow operators to move freely around any workplace or environment
- Available in either pistol or angle configurations



QX Series™ Torque Multiplier  
1620NM High Torque Angle Wrench



QX Series™ 20V Torque  
Multiplier - Pistol Grip



QX Series™ 40V Torque  
Multiplier for Tire Service

QX™ Series 40V Torque  
Multiplier 1000NM Pistol Grip

# ADAPTABLE TO YOUR APPLICATION

From pipeline flange bolts to truck frame assembly and complete tire service, the QX Series™ Cordless Torque Multipliers have the range, accuracy and configurations to tackle your fastening, fastening and bolting needs. Sharing the same IQV40™ Series power platform with our high torque angle wrench, assembly tools, the torque multiplier expands our broad range of cordless bolting solutions.



### Agriculture & Heavy Equipment



- Chassis & Suspension
- Wheels
- Diesel & Gas Engines
- Tracks

### Infrastructure



- Bridges
- Road Ways
- Steel Structures

### Oil & Gas



- Flanges
- Heat Exchangers
- High Pressure Valves

### Rail



- Rail Car Manufacturing
- Locomotive Assembly
- General Maintenance

### Truck & Bus



- Wheels
- Suspension
- Chassis

### Wind



- Nacelles
- Gear Boxes
- General Maintenance
- Break-ins



# QXM SERIES CORDLESS TORQUE MULTIPLIER FEATURES

Premium gearbox provides proven quality and accuracy

Dual Axis 360° handle provides instant adjustability, maximizing comfort and flexibility when working on multiple joints and applications

Tethering Ring included for safety and drop prevention

Optional Bluetooth and wireless communications for process control with I/O and data collection

USB port for convenient programming and data transfer

Standard or custom reaction arms meet multiple application needs

Proven QX Series™ brushless motor provides maximum durability

Cooling fan operates independent of the drive motor keeping the motor operating in high cycle, large gang count applications

Durable drop resistant steel reinforced motor housing protects against damage.

Non-contacting trigger and reverse switch maximizes durability

Ergonomic design comfortable, lightweight and balanced

Lithium Ion battery provides maximum run time and portability using power platform common to all Ingersoll Rand IQV40 cordless families

Closed-loop transducer control delivers precise torque and accurate, traceable results

Cycle status lights and audible alarm provide instant validation during each operation  
 Red – Above set high limit  
 Yellow – Below set low limit  
 Green – Within set range  
 Blue – Active alarm condition

Backlit display offers quick set-up and easy to read visual feedback

Real time results displayed for every fastening

Bluetooth pairing to your Apple iOS or Goggle Android device

Fully integrated with the INSIGHTQCX™ Controller and INSIGHT Connect app for automatic data capture, easy results sharing and tool programming

IR  
40V

zigbee

# SUPERIOR CONTROL AND COMMUNICATION

Ingersoll Rand® doesn't just give you unprecedented technology, we give you total control of that technology. With up to 32 programmable PSETs configurations per tool, the QX Series™ 40V Torque Multiplier allows operators to transition seamlessly between different bolting applications. You'll be able to use bolting strategies individually, or combined in one strategy depending on what works best for you. Improve ability to record, capture & download data!

## COMMON BOLTING STRATEGIES

### Torque

Achieve desired torque within high and low limits



### Angle

Achieve target rotation within high and low limits



### Gang Count

Counts all rundowns to ensure all bolts have been fastened

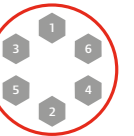

+ If additional control is needed, Ingersoll Rand's INSIGHTQCX Controller or Insight Connect app gives you even more options to adapt to the most complicated bolting applications.



# REACTION ARMS FOR MULTIPLIERS

Ingersoll Rand® offers the following variety of reaction arms for different applications. Reaction arms are available in both 52 mm and 72 mm spline drives, depending on the size of the gearbox.

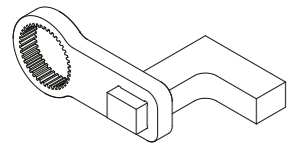

Cranked, 45 or 90 degrees

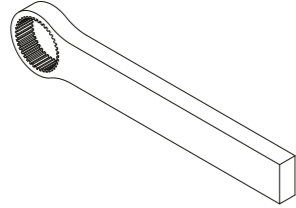

Straight, aluminum or steel (multiple lengths available)

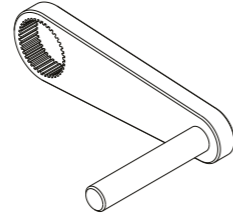
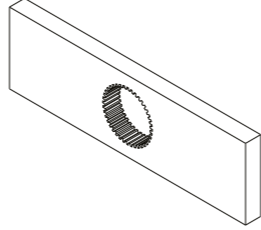
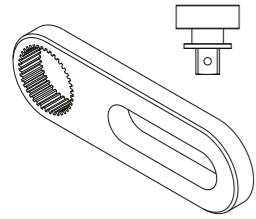

Plate and Peg (multiple lengths available)



Double-sided



Sliding slave kit (multiple lengths available)

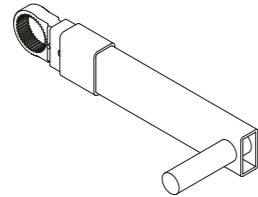

Yoke and tube (multiple lengths available)

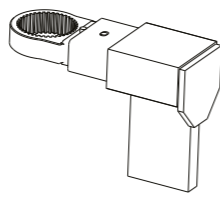

Yoke & Paddle (multiple lengths available)

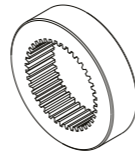

Blank welding ring

Part Number	Spline (mm)	Type	Part Number	Spline (mm)	Type
<b>STEEL</b>					
TP-NSP-766-72WS	72	Truck Tire	NSP-766-72STS070	72	Straight (7")
NSP-766-52-72YP	52-72	Yoke & Paddle	NSP-766-72STS155	72	Straight (15.5")
NSP-766-52-72YTP	52-72	Yoke & Peg	NSP-766-72STSD079	72	Double-Sided (7.9")
NSP-766-52CR	52	Cranked (45deg)	NSP-766-72WR	72	Weld Ring
NSP-766-52CR90	52	Cranked (90deg)	NSP-766-72Y	72	Yoke
NSP-766-52PPS060	52	Plate & Peg	NSP-766-72YPA	72	Yoke & Paddle
NSP-766-52SL	52	Sliding Slave (7")	NSP-766-72YTA	72	Yoke & Tube
NSP-766-52SLK12	52	Sliding Slave	NSP-766-92CR	92	Cranked (45deg)
NSP-766-52SLS050	52	Sliding Slave (5")	NSP-766-92CR90039	92	Cranked (90deg)
NSP-766-52ST	52	Straight (10")	NSP-766-92PP080	92	Plate & Peg (8")
NSP-766-52STS155	52	Straight (15.5")	NSP-766-92SL08	92	Straight (1")
NSP-766-52STSD098	52	Double-Sided (9.8")	NSP-766-92SL12	92	Straight (1.5")
NSP-766-52WR	52	Weld Ring	NSP-766-92STS079	92	Straight (7.9")
NSP-766-52Y	52	Yoke	NSP-766-92STS155	92	Straight (15.5")
NSP-766-52YPA	52	Yoke & Paddle	NSP-766-92STSD095	92	Double-Sided (9.5")
NSP-766-52YTA	52	Yoke & Tube	NSP-766-92WR	92	Weld Ring
NSP-766-72CR	72	Cranked (45deg)	<b>ALUMINIUM</b>		
NSP-766-72CR90	72	Cranked (90deg)	NSP-766-52STA100	52	Straight (10")
NSP-766-72PP100	72	Plate & Peg (10")	NSP-766-52STA155	52	Straight (15.5")
NSP-766-72SL	72	Sliding Slave (8")	NSP-766-92CRA	92	Cranked (45deg)
NSP-766-72SLK12	72	Slave Square Kit (3/4")	NSP-766-92STA155	92	Straight (15.5")
NSP-766-72SLK16	72	Slave Square Kit (1")			
NSP-766-72ST	72	Straight (10")			

Not all applications are equal — Ingersoll Rand offers custom reaction arms. Please see your certified distributor for more information.

# SYSTEM ACCESSORIES

We offer a wide range of accessories that offer ease of use and flexibility to meet your specific application needs. QX Precision Fastening Systems are compatible with a variety of plug and play accessories to maximize productivity for your manufacturing line.

## ACCESSORIES FOR ANY APPLICATION

- Battery chargers
- Battery packs
- Boots
- Bit selector trays
- Socket selector trays
- Suspension bales
- Auxiliary handles
- Selector tray cables
- Torque testers
- Spring balancers
- Socket kits



IQV40 Series 40V, 2.5Ah Battery Charger BC1161-EU



IQV20 Series 20V Battery Charger BC1221-EU



IQV20 Series 20V, 2.5Ah Lithium Ion Battery Pack BL2012



IQV40 Series 40V, 2.5Ah Lithium Ion Battery Pack BL4011



IQV20 Series 20V, 5.0Ah Lithium Ion Battery Pack BL2022



DIO Box QC-DIO-8CH



2.5Ah Battery Boot BL2012



5.0Ah Battery Boot BL2010



VP1-Boot-NP Protective cover with closed back



Light Tower QC-TL-4



Selector Tray Cables IC-10PIN-6M for IC-Socket-4 IC-19PIN-5M for IC-Bit-8 *This is required*



Corded IC-BIT-8



USB Socket Selector Tray QC-SKTR



Pistol Tool Suspension Bale VP1-365



Safety Trigger Kit TK-VP2-075-1 *\* Should be ordered via solution center*



Auxiliary Handle VP1-A48



INSIGHTQCX™ Controller QCXD11



Hard Case TA-VP2-HCS-2



3/4" and 1" Socket Kits SK8C5TN

For a specific part number and ordering details, please refer to the accessories guide at [irtools.com/assemblyaccessories](http://irtools.com/assemblyaccessories)



The INSIGHT™ Connect app will help you stay productive, mobile and in control of your fastening process. It programs any Ingersoll Rand® QX Connect Series™ tool without the need for additional technical training, special software, plant network permissions or a laptop computer. Working from a smartphone or tablet, operators can use the app to quickly program the torque and angle control configurations on these closed-loop, transducerized tools.

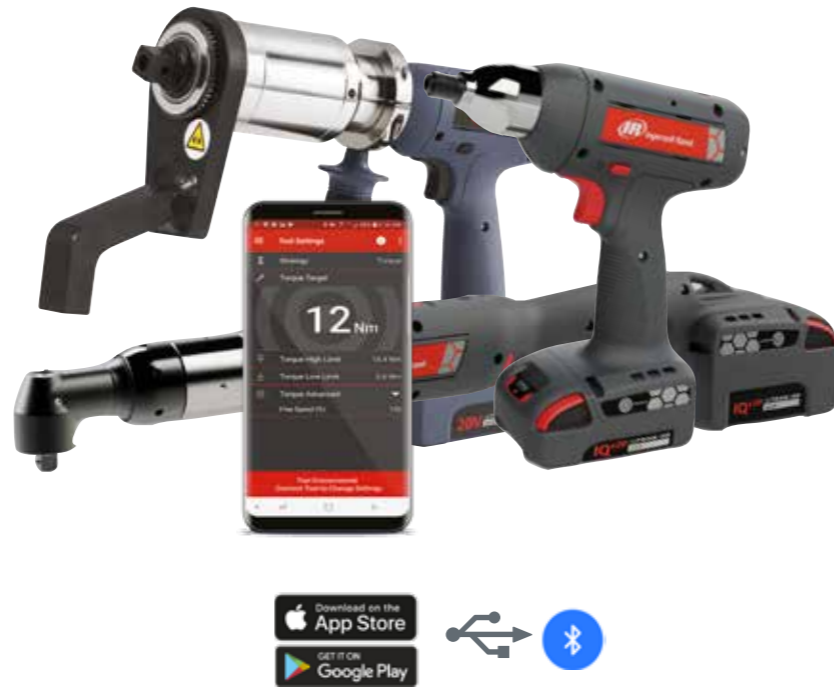

Once installed, the INSIGHT™ Connect app can operate offline, so it functions in large facilities or other locations where Internet signal loss may be a problem, reducing downtime and maximizing ease of use. The INSIGHT Connect App is a perfect companion to complement QX Connect Series™ tools\*. With Bluetooth capability, the INSIGHT Connect App can communicate wirelessly via Bluetooth with the QX Connect tools.

You can quickly perform key tasks with your mobile device, including:

### SIMPLE

- Common Setting & General Tool Setup
- Multiple Language Support
- Retrieve Cycle Log and Share via Email
- Audit Logs
- Error Codes with Description

### FLEXIBLE

- Program All Standard QX Platform Tool
- Clone- Back Up and Restore
- Save and Load Configurations
- Firmware Update
- Virtual tool programming

### CAPABLE

- Program Torque, Angle, Speed
- Multiple PSET Configuration
- Multiple Step Programming
- End of Run (EOR) data on App
- Calibration and Cp/Cpk
- Programming and downloading of data via Bluetooth

# INSIGHTQCX™ CORDLESS CONTROLLER

## THE POWER TO REDUCE COSTS & INCREASE FLEXIBILITY



When trying to achieve simple manufacturing goals in a complex manufacturing world, understanding the fastening process doesn't have to be complicated. The new Ingersoll Rand® INSIGHTQCX™ is different, by design. This cordless controller is designed to be easy to use and integrate, while providing a common platform to meet your assembly requirements worldwide.

With the new Multi Tools Controller (MTC) software option, you also have the ability to control up to 10 tools with just one INSIGHTQCX Controller. Ingersoll Rand's innovative solution with our QX Series™ & INSIGHTQCX MTC Controller provides some of the best value available on the market, with one of the lowest total costs of ownership & cost per spindle available.



SIMPLE

### EXPERTISE NOT REQUIRED

#### WHAT DOES THIS MEAN TO ME?

- Save on selection, training and installation costs
- Reduce errors and downtime
- Remove user dependencies

#### HOW DOES INGERSOLL RAND PROVIDE VALUE?

- Intuitive, visual programming interface
- Plug and play accessories and protocols
- Integrated backup and recovery
- Bundled controller options
- Easy Wireless Pairing (up to 6 tools with MTC option)
- Tightening configurations can be shared between tools (MTC)



FLEXIBLE

### EASILY IMPLEMENT CHANGE

- Reduce line rebalancing costs
- Easy line integration
- Remove device dependency

- Web based programming use any operating system via any browser
- Meets current industry communication needs
- Integrated logic controls
- Easy hardware and software upgrades
- Onboard wireless energy scan



CAPABLE

### MEET YOUR REQUIREMENTS

- Get the job right, every time
- Assurance via traceability
- Optimize your productivity

- Touch screen interface
- Optimal cycle data storage: 500,000 results & trace
- Robust audit and system logs
- Advanced tightening strategies and features
- Onboard diagnostics
- Integrated statistical process controls

## SIMPLY INSIGHTFUL

The controller's web-based software eliminates device dependencies and enables full programming capability with any device that can run an internet browser, including smart phones, tablets or computers. The INSIGHTQCX™ Controller is easy to integrate with the manufacturing line, provides flexible logic controls for job sequencing and helps reduce line rebalancing costs through a simple and intuitive user interface.

# CONTROL MULTIPLE TOOLS WITH 1 CONTROLLER (with MTC option)



- Integrated wall mount
- Configure up to 256 jobs & 32 Psets per tool
- SSD card
- Whiteboard & QR code

- Integrated carrying handle
- Holds 500,000 records for results & trace
- 7-in full color touch screen
- System indicators
  - Factory connection
  - Wireless connection
  - Link status
  - Fault detected



- Ethernet ports 10/100/1000
- USB 2.0 ports (4)
- Fieldbus card slot
  - Ethernet IP
  - Profinet
  - Profibus
  - Devicenet
  - Others

SKU#	Tools to Pair
MTC-SW-OPT2-EU	2
MTC-SW-OPT4-EU	4
MTC-SW-OPT6-EU	6
MTC-SW-OPT10-EU	10

- MTC OPTIONS**
- Up to 6 Tools with QXX & Up to 10 Tools with QXW
  - Unlock Multi tool dashboard view
  - Upgradeable software
  - Backwards compatibility with INSIGHTQCX™ & QX™ tools



# INSIGHTQCX™ CORDLESS CONTROLLER MODELS

The INSIGHTQCX™ Controller is 100% compatible with our QX tools. With the INSIGHTQCX™, the controller can store 500,000 tightening records and 500,000 tightening traces— which will let users understand all facts of the tightening process – torque, angle, time and date.

Model	Display	Fieldbus Options					Mes Options			
		Ethernet I/P	ProfiNET	ProfiBUS	DeviceNET	CC-Link	IR Ethernet EOR	Open Protocol	PFCS	Nissan Serial EOR
QCXD11	YES						•			
QCXD11-F	YES	•	•				•			
QCXD11-M	YES						•	•	•	•
QCXD11-FM	YES	•	•				•	•	•	•
QCXD12-F	YES	•	•	•			•			
QCXD12-FM	YES	•	•	•			•	•	•	•
QCXD13-F	YES	•	•		•		•			
QCXD13-FM	YES	•	•		•		•	•	•	•
QCXD15-F	YES	•	•			•	•			
QCXD15-FM	YES	•	•			•	•	•	•	•
QCXM11	NO						•			
QCXM11-F	NO	•	•				•			
QCXM11-M	NO						•	•	•	•
QCXM11-FM	NO	•	•				•	•	•	•
QCXM12-F	NO	•	•	•			•			
QCXM12-FM	NO	•	•	•			•	•	•	•
QCXM13-F	NO	•	•		•		•			
QCXM13-FM	NO	•	•		•		•	•	•	•
QCXM15-F	NO	•	•			•	•			
QCXM15-FM	NO	•	•			•	•	•	•	•

## INSIGHTQCX™ MULTI TOOL CONTROL (MTC)

### UP TO 10 TOOLS ON 1 CONTROLLER

- Pair up to 10 Tools on with 1 Controller
- Easy upgrade of 1 tool controller to MTC
- Reduce number of hardware devices
- Full control with flexibility

### QUICK WIRELESS PAIRING

- Easy 2-Steps to pair the controller with a QXX & QXW tools
- Simple 1-Step to unpair
- No PC software required to program
- Pair 10 Tools in about 60 Seconds

### VALUES

- Reduce investment on hardware
- Reduce Integration Investments
- Quick Line Rebalancing
- Consolidate your Toolings

### VALUES

- Improve setup time
- Easily implement changes on the line
- Reduce downtime to swap tool

# INSIGHTQCX™ CORDLESS CONTROLLER CAPABILITIES

Software Capability									
	Standard	F	M	FM		Standard	F	M	FM
Embedded Software	•	•	•	•	Factory Reset	•	•	•	•
Home Screen	•	•	•	•	Network System Discovery	•	•	•	•
JOB Setup	•	•	•	•	License Update	•	•	•	•
PSET Setup	•	•	•	•	License Activate	•	•	•	•
Multiple Tightening Strategies	•	•	•	•	Date & Time Settings	•	•	•	•
Quick Programming	•	•	•	•	System Initialization	•	•	•	•
Advanced Programming	•	•	•	•	IP Address Settings	•	•	•	•
Cycle Results	•	•	•	•	Digital IO Settings	•	•	•	•
JOB Results	•	•	•	•	EOR Data Out	•	•	•	•
Audit Log	•	•	•	•	Barcode	•	•	•	•
Event Log	•	•	•	•	User Management	•	•	•	•
System Diagnostics	•	•	•	•	System Logs	•	•	•	•
Tool Diagnostics	•	•	•	•	Fieldbus Diagnostics	•	•	•	•
Digital IO Diagnostics	•	•	•	•	Fieldbus Settings	•	•	•	•
Statistics Settings	•	•	•	•	Ethernet IP	•	•	•	•
Statistics Summary	•	•	•	•	ProfiNet	•	•	•	•
Statistics Alarm Settings	•	•	•	•	ProfiBus	•	•	•	•
Statistics Alarm Summary	•	•	•	•	DeviceNet	•	•	•	•
Backup and Restore	•	•	•	•	MES Protocols Settings	•	•	•	•
Firmware Update	•	•	•	•	Open Protocol	•	•	•	•
Preventative Maintenance Alarms	•	•	•	•	ToolsNet	•	•	•	•
Tool Calibration	•	•	•	•	VW XML 2.1	•	•	•	•

Torque/Angle Control

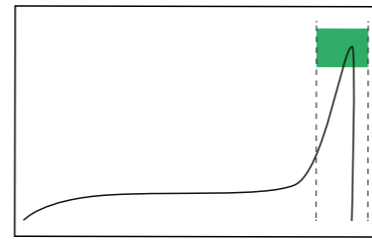

Prevailing Torque

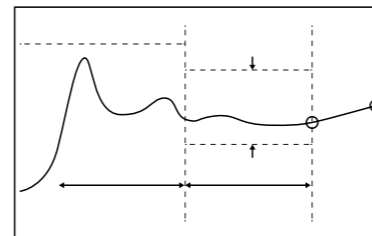

## Statistical Process Control

Statistic Status	Description
Mean	Statistical average - used to derive the central tendency of the tightening data of a particular PSET
Capability	Calculated as $(6 \times \text{sigma} / \text{Mean}) \times 100$ on a particular PSET
Pass %	Indicates the % of the cycles that have a cycle result of PASS from the sample population of a particular PSET
Fail %	Indicates the % of the cycles that have a cycle result of FAIL from the sample population of a particular PSET
Mean Shift	Calculated as: $\text{MEAN Result Value} - \text{TARGET Result Value}$ for a particular PSET
Range	Calculated as: $\text{MAX Result Value} - \text{MIN Result Value}$ of a particular PSET.
Standard Deviation ( $\sigma$ )	The calculated standard deviation ( $\sigma$ ) of the Result Value of a particular PSET.
PP	Process Performance, calculated as: $(\text{USL} - \text{LSL}) / (6 \times \sigma)$
CAM	Calculated as: $(\text{USL} - \text{USL}) / (6 \times (W / d \times S))$
PPK	Process Performance Index, Calculated as: $\text{MIN} ((\text{MEAN} - \text{LSL}) / (3 \times \sigma) \text{ OR } (\text{USL} - \text{MEAN}) / (3 \times \sigma))$

# INSIGHTQCX™ CORDLESS CONTROLLER SPECIFICATIONS

Hardware	Features
Weight (Kg)	2.5
Volume (dm3)	7.5
Colour Touchscreen	7 inch
Ethernet Port (10/100)	1
Ethernet Port (10/100/1K)	1
USB 2.0 Ports	4
Boot Time (seconds)	40
Voltage / Current Requirement	24V / 2A
IP Rating (mounted vertically)	IP52
Software	
PC Software	Not Required
PC License	Not Required
Number of JOBS	256
Number of PSETs (per JOB)	32
Number of Steps (per PSET)	8
Logic Rules for JOB Sequencing	Y
Barcode function: USB, Serial, Ethernet	Y
Manual Barcode Entry Option	Y
Tubenut Controls (Configurable modes)	Y
Number of Configurable User Logins	Unlimited
Quick Programming Mode	Y
Advanced Programming Mode	Y
Unrestricted programming function from controller screen	Y
Unrestricted remote programming from any device via any authorized browser	Y
Embedded, Context-Specific Help *	Y
Email Statistics Alarms Direct From Controller**	N
Email Preventative Maintenance Alarms Direct from Controller	N
Multi-language Support	Y
Onboard Tool Diagnostics	Y (when connected via USB)
Wireless Energy Scan	Y
Easy Pairing	Y
Onboard Data Storage	
Removeable SSD Hard Drive that stores ALL settings and data	Y
Complete controller settings and data recovery through SSD swap	Y
Tightening Results	500.000
Tightening Curve	500.000
Tightening curve displayed on Home screen of controller	Y
Audit Log	50.000
Event Log	10.000
System Log	10.000
Full Backup and Restore Function (USB or from computer/Tablet)	Y
Connectivity	
Fieldbus Options	Ethernet IP, ProfiNet, ProfiBus, DeviceNet
MES Protocol Options	Open Protocol, Ford Open, PFCS, Toolsnet*** 3.2 & 8.0, VW XML 2.0/ 2.1, IR Ethernet EOR, TOHO,
Supported Languages	
English, French, German, Italian, Spanish, Czech, Russian, Portuguese, Polish, Simplified Chinese	

\* Available from June 2020

\*\* Requires proper authorization and network settings by plant IT Administrator for each controller

\*\*\* No Trace Transfer

# INSIGHTQCT™ SERIES CALIBRATION EQUIPMENT

Competition is driving product quality requirements to new levels. Meeting these demands requires keeping your processes in control and your tools working within specifications.

## THE SOLUTION

### INSIGHTQCT™ Series calibration equipment

Our INSIGHTQCT™ Series calibration equipment is the ideal quality control companion for assembly operations with stringent torque control standards. Choose from our offering of easy-to-use torque testers, analyzers, transducers, and joint kits to set up and calibrate your full portfolio of precision tools.

#### IQCTT SERIES TORQUE TESTERS

The IQCTT Series of torque testers includes four different models with integrated transducers that allow rapid and accurate torque checking of fastening tools from 0.1 to 30 Nm (1 to 265 in-lb). The IQCTT's enhanced features include track and peak modes for most hand and power tools, a pulse mode that measures and counts pulses for pulse tools, and a click mode for hand-click wrenches. Included trace and statistical functions support even the most detailed joint analysis and proper decision making.

#### IQCTA SERIES TORQUE ANALYZER

The IQCTA Series torque analyzer shares the same compact, sleek design and impressive feature set, but is designed for portability. It can dynamically measure and record the output of precision fastening tools on the application or the workbench in both directions when coupled with our automatically recognized Smart or Industry



Standard transducers. Joint simulators are also available to emulate different joint rates from hard to soft and can be used with both stationary and rotary transducers when working away from the application.



#### IQCTT TESTER

- Compact bench-mount unit
- Integrated torque transducer in (4) ranges from 1 to 30 Nm
- Large color screen
- Simple programming and navigation
- Full statistical and tightening trace analysis
- Variable rate rundown adapter included
- Rechargeable Li-Ion battery with auto-shutdown feature
- USB port for data export

*Ideal for testing and calibration of lower torque assembly tools in a tool crib, calibration lab, or workstation.*

#### IQCTA ANALYZER

- Lightweight portable unit
- Compatible with full range of Industry Standard (IS) and Smart external transducers
- Large color screen
- Simple programming and navigation
- Full statistical and tightening trace analysis
- Rechargeable Li-Ion battery with auto-shutdown feature
- USB port for data export

*Ideal for use with a broad range of external transducers to test output of assembly tools on the application or wherever torque verification is required.*

#### ACCESSORIES

- Rotary transducers
- Stationary transducers
- Joint simulator kits
- Rundown adapters
- Transducer cables
- Battery charger
- Calibration service

*Take advantage of our extensive line of accessories and services to optimize your assembly and quality assurance processes.*

#### TRANSDUCCERS

Rotary      Stationary



#### JOINT SIMULATION KITS

Rotary      Stationary      Rundown Adaptor



#### OTHER ACCESSORIES

Cable - IS transducer  
Neck strap  
Port saver - 25 pin  
Power Supply

ETA2-TC  
ETA2-STRAP  
ETA2-P525  
IQC-PS5

# INSIGHTQCT™ SERIES TORQUE TESTERS AND ANALYZERS

## POWER AND HAND TOOL COMPATIBILITY

means only one system is needed to setup and calibrate all of your precision tools

## FULL STATISTICAL CAPABILITIES

Include Count, Range, Mean, MIN, MAX, Standard Deviation, Cm, Cmk, Cp, Cpk

## COMPACT AND LIGHTWEIGHT

with rechargeable Li-Ion battery provides ease of use and portability on the assembly line and space savings on the workbench

## LARGE COLOR SCREEN

shows clear, easy-to-read test results, menus, and traces

## SOFT-TOUCH KEYPAD

and intuitive menus make navigation and test setup quick and simple

## AUDIBLE AND VISIBLE INDICATORS

give High, Low, and Pass cycle status



## TYPICAL SCREEN



- Monitors bi-directional torque, angle, time, RPM & pulse count
- Supports onboard trace analysis and data export
- Reads in peak, click, pulse, or track mode
- Stores 999 time-stamped readings
- Auto-recognition of Smart transducers
- Selectable filter frequencies
- USB data export for readings and trace data
- Configurable Auto-print function via USB
- Eleven (11) units of measure
- Adjustable power-save settings
- Multi-language support for English, French, German, Italian, and Spanish

## IQCTA SERIES – INSIGHTQCT™ TORQUE ANALYZER

Model	Compatible Transducer	Data Transfer	Auto Recognition	Screen Size (mm)
IQCTA	TRD TR TRDA TSD TS Industry Standard UTA	USB (csv) Printer	Yes	85x50 mm



## IQCTT SERIES – INSIGHTQCT™ TORQUE TESTER

Model	in-lb Range	Nm Range	Rundown Adaptor*	Service Kit
IQCTT-1	0.88 - 8.8	0.1 - 1	ETT-RA-1	ETT-RA-1-KIT
IQCTT-4	3.50 - 35	0.4 - 4	ETT-RA-4	ETT-RA-4-KIT
IQCTT-12	10.6 - 106	1.2 - 12	ETT-RA-12	ETT-RA-12-KIT
IQCTT-30	26.5 - 265	3.0 - 30	ETT-RA-30	ETT-RA-30-KIT

\* IQCTT tester includes rundown adaptor, carrying case, power supply, manuals, and a certificate of calibration. IQCTA analyzer includes carrying case, power supply, manuals, and neck strap.

**QUICK DOWNLOAD OF** results to printer or USB for data analysis, graphing, documentation, or calibration

**Dimensions**  
209 x 194 x 78 mm

**Weight**  
2.2 lb / 1.0 kg (IQCTA)  
4.5 lb / 2.1 kg (IQCTT)



## TRANSDUCERS

ROTARY	Industry Standard	Smart Transducers		(in-lb) ft-lb	Nm	in
		Torque Only	Torque and Angle			
	TR2H4	-	-	(1.0 - 18)	0.10 - 2	1/4
	TR5H4	TRD5H4	TRDA5H4	(2.2 - 44)	0.25 - 5	1/4
	TR20H4	TRD20H4	TRDA20H4	(9.0 - 180)	1 - 20	1/4
	TR20S4	TRD20S4	TRDA20S4	(9.0 - 180)	1 - 20	1/4
	TR75S6	TRD75S6	TRDA75S6	2.8 - 55	3.8 - 75	3/8
	TR180S8	TRD180S8	TRDA180S8	6.7 - 133	9 - 180	1/2
	TR250S12	-	-	9.2 - 185	12.5 - 250	3/4
	TR500S12	TRD500S12	TRDA500S12	18.5 - 370	25 - 500	3/4
STATIONARY	TS30S4	TSD28S4	-	1.1 - 22	1.5 - 30	1/4
	TS150S6	TSD135S6	-	5.5 - 110	7.5 - 150	3/8
	TS300S8	TSD270S8	-	11 - 221	15 - 300	1/2
	TS1000S12	TSD1000S12	-	37 - 738	50 - 1000	3/4

## JOINT SIMULATORS

ROTARY	Industry Standard	Includes Transducer	Joint Simulator Bolt Service Kit	ft-lb	Nm	in
	JKR75	No	JKS150-BKIT	2.8 - 55	3.8 - 75	3/8
	JKR180	No	JKS300-BKIT	6.7 - 133	9.0 - 180	1/2
	JKR500	No	JKS1000-BKIT	18.5 - 370	25.0 - 500	3/4
STATIONARY	JKS30	No	JKS30-BKIT	1.1 - 22	1.5 - 30	1/4
	JKS150	No	JKS150-BKIT	5.5 - 110	7.5 - 150	3/8
	JKS300	No	JKS300-BKIT	11.0 - 221	15 - 300	1/2
	JKS1000	No	JKS1000-BKIT	37.0 - 738	50 - 1000	3/4
	JKST30	TS30S4	JKS30-BKIT	1.1 - 22	1.5 - 30	1/4
	JKST150	TS150S6	JKS150-BKIT	5.5 - 110	7.5 - 150	3/8
	JKST300	TS300S8	JKS300-BKIT	11.0 - 221	15 - 300	1/2
JKST1000	TS1000S12	JKS1000-BKIT	37.0 - 738	50 - 1000	3/4	











Ingersoll Rand driven by an entrepreneurial spirit and ownership mindset, is dedicated to helping make life better for our employees, customers and communities. Customers lean on us for our technology-driven excellence in mission-critical flow creation and industrial solutions across 40+ respected brands where our products and services excel in the most complex and harsh conditions. Our employees develop customers for life through their daily commitment to expertise, productivity and efficiency.